

# Northcote Leader

Circulating in Northcote, Preston, Thomastown, Epping, Diamond Creek, Arthur's Creek, Whittlesea, Fairfield, Heidelberg, Clifton Hill

**NORTHCOTE LIBRARY**  
All Privileges Free to Residents  
**8500 Volumes.**  
Best Fiction.  
Finest Literature.  
Excellent Books for Young Folk.  
R. J. Whalley, Hon. Sec.

**S. TURNER**  
(Late A.I.F.)  
LANDSCAPE GARDENER, &c.  
EDWARDS ST., RESERVOIR.  
Gardens Laid Out and Kept in Order.  
Plants of all kinds supplied.  
Paths and Drives in Granolithic, Gravel or Asphalt.  
Manure, Garden Soil, Ashes, &c.  
Any Suburb.

**Dentistry**  
**Dental Advice Free.**  
Mr. O. J. A. TAYLOR, formerly assistant to Dr. Hay Tovey and Dr. W. L. Aiken. Specialized in all branches of dentistry. 258 HIGH STREET, NORTHCOTE (near Picture Theatre).  
Phone, Northcote 640.

**C. J. A. TAYLOR**  
(Recorded by Dental Board, Vic.)  
258 HIGH STREET, NORTHCOTE  
(near Picture Theatre).  
Phone, Northcote 640.

**C. J. GORDON GILLIES**  
L.D.S., B.D.Sc.  
Melbourne University,  
SURGEON DENTIST,  
HIGH STREET, THORNBURY  
(next Davis, Chemist).  
Hours: 9.30 a.m. to 1 p.m., 2 p.m. to 6 p.m.  
Monday and Friday, 7 p.m. to 9 p.m.

**M. R. GEORGE M. ALLEN,**  
SURGEON DENTIST,  
OF 32 Collins Street, Melbourne, announces that he has established a branch of his practice at 140 High St., Preston South, and he may be consulted there every evening and on Saturdays. Week-day appointments must be made previously to ensure of prompt attention. Telephone, 31613.

**J. E. ANDREA,**  
L.D.S., B.D.Sc.,  
MELBOURNE UNIVERSITY,  
SURGEON DENTIST,  
763A HIGH STREET, THORNBURY  
(3 doors from Dyte, Chemist).  
Hours: 9 a.m. to 6 p.m. Daily.  
Monday, Wednesday, and Friday, 7 to 9 p.m.  
Phone, Northcote 1932

**Electrical Installations**  
Guaranteed All British.  
No Wood Casing. No Japanese.  
**24/- per Light.**

**F. QUAIFE,**  
LICENSED CONTRACTOR  
"Airtie," Collins St., PRESTON.

**Johnston & McMillan,**  
ELECTRICAL CONTRACTORS,  
668 HIGH STREET, NORTHCOTE  
Private Address:  
251 Fenwick Street, Northcote.  
And enr. Wales & Rosemary Sts.

Electric Lights, Fans, Motors, and Anything Electric Installed.  
REPAIRS A SPECIALTY.

ALL WORK GUARANTEED.  
Estimates Free. Phone—N'cote. 471.

**Bell Fibro-Plaster Sheets**  
(All Sheets Branded).  
MADE ALL SIZES.  
Inspect at Factory before Ordering Elsewhere.

BLANCH STREET, PRESTON  
(near Bell Station).  
Phone, Northcote 1482.

**LONDON Fire Assurance.**  
You can insure your Buildings, Furniture, Stocks-in-Trade against Fire at Lowest rates.  
Consult Local Agent,  
**ERNEST LEES**  
307 HIGH STREET, NORTHCOTE.  
Telephone, Northcote 64.

**"Rona" Dairy Farm**  
Farm and Dairy:  
SPRING STREET, PRESTON.  
Pure, Fresh Milk, direct from our own cows, delivered twice daily in Preston and surrounding districts.  
Premises and Cattle under Government supervision.  
Our Milk is guaranteed free from preservatives and coloring.  
Post Cards promptly attended to.  
The favor of your patronage and recommendation respectfully solicited.

**B. EDMONDS,**  
LICENSED DAIRYMAN.

**Undertakers**  
Telephone J1066.  
**H. J. R. LEWIS,**  
UNDETAKEE  
And CHRISTIANIZED EMBALMER,  
HIGH ST., NORTHCOTE.  
Head Office:  
Corner Johnston & Hertford Sts., Fitzroy.

Funerals conducted at the lowest possible rates.  
Licenses, Mortuary Certificates, and Funeral Requisites.  
The trade supplied.

Established 1855.  
**W. G. APPS Pty. Ltd.**  
UNDETAKEE,  
Meor Street, Fitzroy.  
High and Robt Streets, St. Kilda.  
Branch: Burgundy Street, Heidelberg.  
Phone, Heidelberg 604.

Price 2d

Registered at the General Post Office, Melbourne for transmission by post as a Newspaper.

Saturday, June 6, 1925

Printed and published by Decimus Thomas Mott, for the Proprietors, D. H. Mott & Sons, at their Printing Office, 107 High Street, Northcote, in the State of Victoria.

**Fuel Merchants**  
**RETURN TO LOWER PRICES**  
Grey Box, 1ft. 2/10 13/9 21/7 22/10  
Red Box, 1ft. 2/8 13/ 21/6 22/10  
Mixed Blocks, 1 foot 2/6 12/ 21/3 22/6 6  
Maitland Coal 3/3 16/ 21/11 23  
Mallee Roots 2/9 13/3 21/6 22/11/6  
Buy your supplies during the summer months and save money.  
Prime Mill Cut Chaff, Crushed Oats, Bran, Pollard, Straw, Grain, and Poultry Feed of all descriptions always on hand in large and small quantities.  
Deliveries daily. Prices on application.

**Charles Rose**  
66 ST. GEORGE'S ROAD,  
NORTHCOTE.  
Wholesale and Retail.  
Phone, Northcote 459.  
All orders left with W. McLeod, 83 Itham Street, Preston, will receive Prompt Attention.

**E. F. Blampied,**  
FUEL MERCHANT,  
88 GLADSTONE AVENUE, NORTHCOTE.  
ON SALE:  
Wood, Coal, Coke, and Mallee Roots at Melbourne Prices.  
A Trial Solicited. Orders delivered to any address.  
Phone, Northcote 146.

**John Kidd**  
Intimates that his well-known PRODUCE AND FUEL BUSINESS, HIGH STREET, CROXTON, will hereafter be run as  
**J. KIDD & SONS**  
(Mr. Jack Kidd, late A.I.F.)  
The New Firm respectfully solicit a fair share of public patronage. All orders promptly attended to.

**A. C. (Bert) HOOPER**  
DESIRES to inform the Residents of Northcote and Preston that he has purchased the FUEL AND FODDER BUSINESS of Messrs Carling Bros., at the corner of St. David and Raleigh Streets, Thornbury.  
He trusts by civility and strict attention to business to merit a share of their patronage.  
Phone N'cote 221.  
Private Address: 38 St. David Street.  
Orders may also be left with Carling & Sons, 439 High Street, Northcote.

**S. T. Muller,**  
WOOD, COAL AND COKE MERCHANT,  
4 SMITH ST., THORNBURY  
(One door from High Street, just behind H. C. Dyte, Chemist).  
Beat Box Wood, Split Wood, Iron Bark, and Mallee Roots delivered at Melbourne Prices.  
All orders promptly attended to. A Trial Solicited.

**PETER O'NEILL**  
has for sale  
Chaff, Oats, Bran, Pollard, Fodder, Etc.  
Wood, Coal, Briquettes, Etc.  
443 HIGH STREET, NORTHCOTE  
(Opposite Brick Co.)

**L. A. Akers,**  
Wood, Coal and Coke Merchants,  
29 DENNIS ST. & 13 DALLEY ST., NORTHCOTE.  
Beat Box Wood, Split Wood, Iron Bark, and Mallee Roots delivered at Melbourne Prices.  
BRIQUETTES.  
Orders delivered to any address.  
A Trial solicited.

**Notices.**  
ACCOMMODATION FOR WEEK-ENDERS.  
Tariff Moderate.

**The Whittlesea Tea Rooms**  
(Opposite Royal Mail Hotel, Walnut St.)  
MRS. H. RICHARDSON, Proprietress  
Lunches Provided at all Times—Hot Pies, Fruit and Cheese Confectionery, Tobacco and Cigarettes.  
Dining Room Open—Three Course Dinner.  
Cooked Meats a Speciality.  
Hot Water Provided.  
Cool Drinks and Ice Cream.

**M. CHAPMAN**  
(Late Plumbing Inspector M.B.B.W.)  
SANITARY AND GENERAL PLUMBING.  
Estimates given for House Connections, Plumbing and Drainage Work.  
General Repairs. Motors Fixed.  
Satisfaction Guaranteed.  
29 KEMP STREET, CROXTON.  
Phone, Northcote 1488.

**E. Weightman,**  
MOTOR CARRIER.  
CARRIES WHAT? ANYTHING—EVERYTHING.  
Solicits Local Work.  
Beat, Rail, City and Suburbs.  
Plenies Attended.  
17 FLANAGAN STREET, PRESTON.

Established 88 years. Phone, Northcote 1201.  
**Arthur R. Bostock,**  
Wholesale and Retail  
**Hay, Chaff, Straw, Grain and Seed Merchant,**  
481 High Street, Northcote.  
POTATOES. ONIONS.  
Agent for Cuming Smith's Manures, Charcoal, Victorian Browns and Black Coal. WOOD, COAL, COKE, Mallee Roots, Clothes Lines and Props. Shell Grit, Oyster Grit, Quartz Grit, Chicken and Canary Grit. Agents for Clarke, King's, White & Handcock, Tyzack's, Chicken and Poultry Requisites, Foods, Condiments, Spices and Medicines. Raswood Spices. Dog Biscuits.  
Oat Hulls, Hulled Oats, Oats, Part. Peas, Bran, Bran, Dun Pens. Canary, Finch, Parrot and Cockatoo Seeds.  
Malt Combing, Pollard, Mixed Grain. All kinds Vegetable Seeds.  
Polly Feed, Wheat, Growing Grain, Molasses, Wheat Screenings, Growing Mashies for Chickens, Lucerne Chaff, Malt, Laying Mash, Malt Meal, Pea Meal, Lupul, Barley, Barley Meal.  
Market Garden Manures, Blood and Bone Manure, Bone and Super Manure, Bone, Blood, Sulphate of Ammonia, Red Oil for Spraying.  
Merial, Peston, Vermil Powders, Drenches, Condition Spices, Colic and Cough Cures for Horses and Cattle, Oil Cake, Calf Food, Sulphur, Salt Petre, Blue Cement, Axle Oils, Greases, Leather Oils and Harness Dressings, Stockholm Tar, Halters, Brooms, Axe and Broom Handles, Whips, Poultry and Pigeon Rings and Leg Bands, all sizes, Egg Preservatives, Twine.

  
**Plenty Motors Pty. Ltd.**  
214 High Street, Preston,  
announce  
**BIG REDUCTIONS**  
in the prices of  
**FORD CARS AND TRUCKS.**  
Note them.  
DE LUXE TOURER ... £199/10/- Very Easy Terms.  
STANDARD TOURER ... £179/10/-  
ONE-TON CHASSIS ... £148

**MAC'S Steam Laundry,**  
656 High Street, Thornbury.  
(O. Du Feu, Prop.)  
ESTABLISHED LAUNDERERS—NOT AGENTS.  
Collars Ironed and Polished Perfectly and Shaped to fit you in comfort.  
NOT BROKEN BY OUR NEW METHOD.  
Dress Shirts done by us are a feature.  
Motor Coats, Curtains, Blankets, Table Cloths, Costumes, Quilts, Sheets,  
And EVERYTHING WASHABLE.  
Don't have the unpleasant wash day at home. We call and deliver any address for your household linen. Wash and iron it ready for use again. You save the washerwoman and firewood expense.  
Just Try it and see how Happy Home Life will be.  
Apply to us for Price List.

**McALPIN'S**  
Other Flours Entirely Eclipsed  
The Malto-Pepsin process is registered solely by McAlpin's, while McAlpin's is the only Super-Milled Flour.  
The only Flour in Victoria packed in Gemfood Cartons.  
It's Different!  
MALTO-PEPSIN SELF RAISING FLOUR

**Hooper's Northcote Auction Mart,**  
Established 1920  
Note Address: 336 High Street  
(Opp. Henderson's, Butcher)  
**General Auctioneer.**  
Sales in Rooms Fortnightly—FRIDAYS at 1.30.  
Furniture, Poultry, &c., Sold on Commission. Goods also sold Privately for Vendors. We send our Wagon anywhere Promptly.  
Large Rooms for Display of Goods.  
**A Large List of House Properties.**  
Auction Sales of Furniture and Properties Conducted on Premises.  
PHONE, N'COTE 946

**W. SMITH,**  
GENERAL MOTOR CARRIER,  
Murray Road East, Preston  
Furniture Carefully Removed to Any Suburb.  
Boat and Rail Attended. Picnic Parties Catered for.  
Phone, Northcote 923

**R. B. LAWRENCE**  
PTY. LTD.  
Dyers, Cleaners, and Feather Dressers,  
Suits or Dress like New by Latest Process.  
Goods may be left at Office and Works: Cunningham Street, Northcote. Shops: Pink's Buildings, 6a Elizabeth Street (next Craig's), Royal Arcade, Bourke Street, and all Suburbs.  
Phone 10430, and Van will call.  
NOTE.—WE HAVE NO SHOPS IN NORTHCOTE

**TANKS OF EVERY SIZE SUPPLIED**  
Every home should have "lathuns" of water—not just enough to skip along on if the seasons are favorable. An extra tank or two conveniently placed round the home will save the women-folk much weary water carrying and perhaps enable you to enjoy more of the real comforts of life.  
We supply all kinds and sizes of Tanks also pipes, gutters, taps, etc. Complete water services installed.  
**W. J. INGLIS PTY. LTD.**  
The Preston Timber Yard and Hardware Stores,  
Glazing and Joinery Works  
Cr. Plenty Rd. and Osborne Grove, Preston  
PHONES—N'cote 1209 and 737

**GRAVEL! GRAVEL! GRAVEL!**  
Just What's Wanted for  
Garden Paths, Yards, and Public Highways.  
Supplied in any quantity at FIRST COST, direct from the Truckers Hill Gravel Pit.  
Order Now, before the Wet Season arrives.  
Full Information at—  
**44 James Street, Northcote.**  
Letters Promptly Attended to. Phone, Northcote 776

Phone, Northcote 1166.  
**Nankervis & Spurr**  
(Late Kellow-Falkiner),  
Motor Engineers,  
209-211 High Street, Northcote  
(Opposite Northcote Theatre)  
All Makes of Cars Overhauled and Repaired. Tuning and Electrical Systems a Speciality. First-Class Work at a FAIR-DEAL PRICE. Full Supply of Petrol and Oil always on hand.  
**Let Us Quote You for your Next Engine Overhaul.**

**DAREBIN MOTORS**  
"THE FIRM WHO CARES."  
Authorized Agents for—  
**CHEVROLET**  
Cars and Trucks.  
Demonstrations with pleasure.  
We have Expert Mechanics and we Specialise in Ford Repairs. A Complete Stock of Genuine Ford Parts and Accessories. So Bring Your Ford Cars to us for inspection. TRY OUR MOTOR SPIRIT  
160 gals. Sold Daily.  
Phone N'cote 1215.  
SHOW ROOMS AND SERVICE STATION—  
96 HIGH STREET, PRESTON.

Be Up-to-Date and have Electric Light Installed in Your Home.  
Clean. No Matches. No Mantle Bills. A Pleasure to Read or Work by. Installations Cheaply and Promptly Executed by  
**H. P. LEE, Electrical Contractor**  
228-230 High Street, Preston.  
Every Class of Electrical Work Undertaken and Satisfaction Guaranteed.  
Phone, Northcote 103.

**T. H. NEAVAN, Farrier,**  
Desires to notify the Public of Northcote, Preston, and surrounding districts that he has taken over the Business lately carried on by Mr. J. S. BURNS, at  
**417 HIGH ST., NORTHCOTE**  
(Next Corner Elm Street).  
Full Experience. All Work Guaranteed.

**FURNITURE**  
REMOVED PACKED or STORED  
CHEAPLY AND WITH CARE  
BY  
**Knapp & Mitchell,**  
82 Helen Street, Northcote.  
Phone, Northcote 253  
Sand, Garden Soil, Ashes and General Carting Done.

Phone, Northcote 222  
**T. A. Sands,**  
Leather and Grindery Depot,  
333 High Street, Northcote  
Boot Repairs a Speciality.  
The Shop where you will get Full Value for Your Money.  
A Few of My Prices:  
Solid Leather School Bags, 2/- each.  
Child's Lunch Cases, 1/- each.  
Men's Solid Leather Lunch Bags, with strong lock, only 8/-  
Lovely 20in. Suit Case of Strong Fibre, 5 Vulcanite Corners and 2 Strong Locks, 12/6 each  
Ladies—See Our Lovely Shopping Cases from 7/6 each  
We carry a Large Selection of Globlito and Solid Leather Attache and Suit Cases, also Ladies' and Gents' Wallets.  
Men's Leather Half Shoes, 1/- per pair  
Men's Rubber Heels, 3d pair; 5 pairs, 1/-  
Strong Boot Laces, 2d per doz.

  
SMITH ST. (at Johnston St. Section).  
NEW STOCK of  
**OSMANETTE**  
Guaranteed for Hard Wear  
In Stripes of Attractive Design.  
31 inch, 1/6 yd. 36 inch, 1/8, 1/11 Plain White or Cream, 31 in. 1/4, 36 in. 1/8  
Men's Pyjama Suits—Our Make—11/6, 13/6  
Boys' Shirts—Our Make—2/11 to 5/6  
Boys' 2-piece Pyjamas, 5/11, 6/11  
Special Sizes Shirts and Pyjamas Made to Order.

**L. H. TADICH'S**  
MOTOR GARAGE  
802 High Street, Northcote  
(TRAM TERMINUS).  
Authorized Sole Agent for  
**Oldsmobile Six, £340**  
Standard Tourer De Luxe £54  
Fitted with Balloon Tyres. CASH or TERMS.  
Jewett Cars, £475  
Your Old Car Taken in Part Payment.  
Demonstrations with Pleasure at Your Leisure.  
REPAIRS BY EXPERTS. COMPLETE SERVICE.  
Try our First Grade Motor Spirit.

**CAHILL & SONS**  
242 St. George's Road, Croxton.  
Licensed Sanitary Plumbers.  
ESTIMATES SUBMITTED. HOT WATER A SPECIALTY.  
Repairs of All Descriptions Promptly Attended to.

**Normanby Hall,**  
Normanby Avenue, Thornbury  
Available for Weddings, Parties, and Dances.  
**Bell's High-Class Catering**  
either at or away from the Hall.  
Highest Satisfaction Guaranteed. Goods on Hire.

**The Northcote Red Granolithic Footpath Experts**  
**A. A. FAIRWEATHER & SONS**  
(Returned Soldier).  
35-37 Herbert St., Northcote  
Footpaths, Garage Drives, Factory and Shop Floors Laid Down and Finished to Satisfaction.  
Cement Steps and Drains to match path.  
All Work Done by US Guaranteed. Material & Workmanship Perfect.  
For Particulars, Ring Northcote 1747.

**Sulphate of Ammonia**  
The Ideal Nitrogenous Fertilizer  
For Lawns, Flower and Vegetable Gardens.  
1/8 per pkt., containing approx. 6 lbs.  
For Renovating Paths, Asphalt Yards, &c.  
4/- per tin, containing approx. 4 gallons.  
Obtainable at ALL DISTRICT DEPOTS.  
Further Particulars from the Producers.  
**The Metropolitan Gas Company,**  
196 FLINDERS ST., MELBOURNE.









Notices
J. W. MOUNSEY, Fuel and Fodder Merchant. 370-386 High Street, NORTHCOTE. All Classes of Fuel Kept in Stock. Phone, Northcote 1484

SEE THE DISPLAY IN AUTUMN HATS at the RENE MILLINERY PARLORS, High St., Northcote (cnr. Beaver's Road). Mrs. D. GREEN, Proprietress.

The Right Place to Buy the Right Gifts. JEWELLERY is the Gift of Gifts, and whether it be a Diamond Ring or some simple little article for a Lady's Toilet Table it should be of good quality. Wm. Thackray 313 HIGH STREET Northcote

PAINT AT PRIDGEON'S White and Colors at 17/6 gallon. DURALENE PAINT. In Specially Prepared to meet the requirements of the Householder for both Exterior and Interior Use.

Pridgeon's Paint and Paper Store, 391 High Street, Northcote. Three doors north of Arthurton Rd. Phone, Northcote 168

You Pay Me Less For Better Teeth. HERE'S a fair enough offer! I'll make you a Set of teeth as perfect as can possibly be made. Rolyat Teeth. C.J.A. Taylor, 258 HIGH STREET NORTHCOTE

SOCCER. PRESTON VS FOOTSCRAY THISTLES. Preston journeyed to Yarraville to play Footscray Thistles last Saturday in the league tourney. Although Preston lost by 4 clear goals, it does not represent the nature of the play. Both teams turned out at full strength.

At the change of ends the game settled down to a very even order, but luck was still out for Preston. Hubbard headed the ball on the cross bar; Kelly hit the upright with a beautiful ground shot; and Capt. Boniface led the bar upon two occasions, all these raids coming from the ground work of Eccles.

William Barton, Victoria street, East Brunswick, was charged with driving a motor car in manner dangerous to the public on High Street on April 30. Herbert Bates was driving a motor cycle south along High Street when near Westgate he was driving a motor car in the opposite direction, evading round into Westgate street.

FOOD PROSECUTIONS. James Dunbar, grocer, High Street, Northcote, was charged with selling adulterated coffee on April 22. Mr. A. M. Lorie (Maddock, Jamieson and Lorie) appeared to prosecute on behalf of the council.

RESERVOIR ROVERS. This club is making progress. They have marked out their ground and placed the boxes for the goal posts, and are ready for games to be played. They are hoping to start in Division 4 and play league games. We wish them good luck in their venture.

CRUELTY TO HORSES. John Barrett, dairyman, of Station street, Fairfield, was charged on May 22, being the owner of three horses, which were confined in a yard, he failed to provide them with sufficient shelter.

POSSESSION OF LAMPS. James Barrett, Station street, Fairfield, was charged that on May 22, he had in his possession four lamps suspected of having been stolen.

WANTED TO BUY. BOTTLES, Bones, Rags, Zinc Lead, Brass and Copper. Highest price given. Cash on delivery. Letters receive prompt attention. H. Bishop, Daresburg Rd., Northcote. Phone. 968.

WANTED TO BUY. FURNITURE, POLITY, &c. in Best Condition. HENDERSON'S NORTHCOTE AUCTION ROOMS, 238 High Street (opp. Henderson's, Butcher). Goods sold at auction and privately. Large Premises for Display of Goods. We send our own wagon anywhere. Prompt settlements. Phone N'cote 946

WANTED TO BUY. FURNITURE OF ALL KINDS. In Large or Small Quantities. Top Price Given. Goods Sold on Commission. Diningroom Suites Re-upholstered.

WANTED TO BUY. FURNITURE OF ALL KINDS. In Large or Small Quantities. Top Price Given. Goods Sold on Commission. Diningroom Suites Re-upholstered.

WANTED TO BUY. FURNITURE OF ALL KINDS. In Large or Small Quantities. Top Price Given. Goods Sold on Commission. Diningroom Suites Re-upholstered.

WANTED TO BUY. FURNITURE OF ALL KINDS. In Large or Small Quantities. Top Price Given. Goods Sold on Commission. Diningroom Suites Re-upholstered.

WANTED TO BUY. FURNITURE OF ALL KINDS. In Large or Small Quantities. Top Price Given. Goods Sold on Commission. Diningroom Suites Re-upholstered.

WANTED TO BUY. FURNITURE OF ALL KINDS. In Large or Small Quantities. Top Price Given. Goods Sold on Commission. Diningroom Suites Re-upholstered.

WANTED TO BUY. FURNITURE OF ALL KINDS. In Large or Small Quantities. Top Price Given. Goods Sold on Commission. Diningroom Suites Re-upholstered.

Milady's Corner. BY MOTHER MEG. WEAR YOUR CLOTHES WITH AN AIR. Some girls have the illusion that if they only possessed the means to indulge in an extravagant wardrobe they could in consequence acquire the gift of wearing clothes with an air which really means an utter absence of self-consciousness.

THE GREAT ART OF DEPARTMENT IS FULLY MASTERED BY THE WELL-BORN FRENCH. The secretary of the department in the bedroom to all details of her dress, brings them to the full perfection of neatness and the latest fashions.

MAKE YOURSELF A BAG. It is so easy to make one of the new flat bags yourself, and so inexpensive, here is a simple plan. Use an old book cover that is quite firm and strong.

COPI-CATS. We are still having copying men's clothes, and soon there will be no more in the garment not imitated. As it is, we have descended to the level of a man's singlet jumper is to any black or white with our walking suits.

BEFORE GOING TO THE PARTY. Every girl likes to look her best at a party, but unfortunately all of them do not. Here are a few tips which may be of use to it.

TO RENOVATE YOUR FROCK. If you want to renovate your last year's frock, here is a very good and simple method of splitting, and wearing out, but you can remedy this, by letting in a deep tuck of grey tulle or lace about half-way up the skirt.

REPAIRING. NORTHCOTE BRANCH. A well-attended general meeting of above branch was held last Monday, Mr. E. Turnbull, the State President being present.

REPAIRING. NORTHCOTE BRANCH. A well-attended general meeting of above branch was held last Monday, Mr. E. Turnbull, the State President being present.

REPAIRING. NORTHCOTE BRANCH. A well-attended general meeting of above branch was held last Monday, Mr. E. Turnbull, the State President being present.

REPAIRING. NORTHCOTE BRANCH. A well-attended general meeting of above branch was held last Monday, Mr. E. Turnbull, the State President being present.

REPAIRING. NORTHCOTE BRANCH. A well-attended general meeting of above branch was held last Monday, Mr. E. Turnbull, the State President being present.

REPAIRING. NORTHCOTE BRANCH. A well-attended general meeting of above branch was held last Monday, Mr. E. Turnbull, the State President being present.

REPAIRING. NORTHCOTE BRANCH. A well-attended general meeting of above branch was held last Monday, Mr. E. Turnbull, the State President being present.

REPAIRING. NORTHCOTE BRANCH. A well-attended general meeting of above branch was held last Monday, Mr. E. Turnbull, the State President being present.

REPAIRING. NORTHCOTE BRANCH. A well-attended general meeting of above branch was held last Monday, Mr. E. Turnbull, the State President being present.

REPAIRING. NORTHCOTE BRANCH. A well-attended general meeting of above branch was held last Monday, Mr. E. Turnbull, the State President being present.

REPAIRING. NORTHCOTE BRANCH. A well-attended general meeting of above branch was held last Monday, Mr. E. Turnbull, the State President being present.

SWITCH ON one of our Radiators and Keep the Cold Out. Look at This: The Northcote, 45/- The Thornbury, 49/6

E. W. BRIGHTON, Electrical Engineer and Contractor. Tram Terminus, 820 High Street, Thornbury. LIGHTS, MOTORS, ANYTHING ELECTRICAL INSTALLED. BATTERIES BOUGHT AND CHARGED.

RADIATION ELECTRIC COY. Radiators a Speciality Radio Parts of Every Quality. Our Address is 241 High Street, NORTHCOTE.

WE CATER FOR ALL. ELECTRIC IRONS, from 21/- to 42/- RADIATORS, from 37/6 to 158/6

Headphones, 17/6. Any Article may be Bought on the Lay-by System. All Classes of Electrical Engineering. Every Kind of Lighting Installations Done. Up-to-date Battery Charger.

Whittlesea Motor Garage. Authorised Ford Dealer for the District. Only Genuine Ford Parts stocked, Fitted, and Work Guaranteed. Sixteen years' experience with Motors, here and Abroad.

La Vinnette Toilet Parlors. 113 High Street, Northcote South. Latest Hair Cuts, Treatments, Dyeing, Singeing, Manicuring, Etc. Misses Jones, Prop.

XMAS 1925. Look Ahead! Your Calendars. Order them from "LEADER" OFFICE, 308 High Street, Northcote.

D. H. MOTT & SONS, Proprietors. Calendars, Blotters, Fans, Xmas Novelties, Etc., Etc. Phone Northcote 46, and our representative will call with the Most Complete Range of Samples in the City.

MADDOCK, JAMIESON, AND LONIE SOLICITORS AND CONVEYANCERS. 136 and 138 Queen Street (between Bourke and Little Collins Streets), Melbourne. A. M. LONIE, Trk, U1465.

MADDEN, DRAKE & CANDY SOLICITORS & CONVEYANCERS. "THE OLDFIELD" (First Floor), No. 476 COLLINS STREET. Telephone, Central 195.

HOME AND WILKINSON. SOLICITORS, CONVEYANCERS, &c. Commercial Union Chambers, 418 Collins Street, Melbourne. And at No. 323 HIGH ST., PRESTON.

W. R. VALLE BARRISTER & SOLICITOR, CONVEYANCER & PROCTOR, 413 CHANCERY LANE, MELB. And 115 HODDLE STREET, ABERDEEN. Telephone, Central 3302.

M. R. S. R. ROE, SOLICITOR, &c. 192 HIGH STREET, NORTHCOTE (opposite Post Office). Is now practicing at the above address where he resides and may be consulted at any time.

NORRIS AND NORRIS, BARRISTERS & SOLICITORS, A. J. NORRIS, 11 B. EDWARD ST. SOLICITOR, Commissioner for Taking Affidavits. CITY OFFICE—Bank of New Zealand Chambers, 349 Collins Street. NORTHCOTE OFFICE—182 High Street. PRESTON OFFICE—Star Theatre Buildings, High Street.

FRANK BRENNAN & CO., SOLICITORS, Yorkshire House, 20 Queen St., Melbourne. Trust Money, Awarding Investment. Tel: 7097, 7098. R. H. GRAY, L.L.B. BARRISTER AND SOLICITOR, CONVEYANCER AND PROCTOR. Every kind of Legal Work attended to. Address: 57 James St., Northcote. TEL. N'cote 156

NICHOLA S. O'DONOHUE, BARRISTER AND SOLICITOR, may be consulted any evening at his Residence, 783 HIGH STREET, THORNBURY. City Office:—Melbourne Chambers, 420 Little Collins Street. Phone: J2022 Central 11197. Trust Money to Lend. Neighboring Courts Visited.

OPTICIANS. P. MORRIS, 298 Little Collins St. FOR CORRECT GLASSES. IF YOU WANT YOUR JOB TO LOOK WORTH WHILE, Write to William H. Day, PAINTER, PAPERHANGER, AND GRAINER. Estimates for General Repairs. Temporary Address: P.O., RESERVOIR. STOP! Car for Hire. LUXURIOUS 7-PASSENGER BARLEY SIX. DAY NIGHT. WEEK-END TRIPS A SPECIALTY. CARS REPAIRED in our own Machine Shop. No Repair Too Big. No Job Too Small. Phone, Northcote 1940. F. MALONE, 11 BROOKE STREET, NORTHCOTE. CARS FOR HIRE. LATEST SIX-CYLINDER TOURING CARS. REDUCED RATES. PICNIC, RACES, SPORTING PARTIES CATERED FOR. Special Prices for Holiday and Country Trips. Ring Northcote 1302. 116 Westbourne Grove. SMITH & CULLEN. SIGNWRITERS. 77 PENDERS STREET, NORTHCOTE. GLASS GILDING, CALICO AND POSTER SIGNS, MOTORS, ETC. Phone, Northcote 1588

**NORTHCOTE LIBRARY**  
All Privileges Free to Residents  
**8500 Volumes.**  
Best Fiction.  
Finest Literature.  
Excellent Books  
for Young Folk.  
R. J. Whalley, Hon. Sec.

# Northcote Leader

Circulating in Northcote, Preston, Thomastown, Epping, Diamond Creek, Arthur's Creek, Whittlesea, Fairfield, Heidelberg, Clifton Hill

**S. TURNER**  
(Late A.I.F.)  
LANDSCAPE GARDENER, &c.,  
EDWARDES ST., RESERVOIR.  
Gardens Laid Out and Kept in Order.  
Plants of all kinds supplied.  
Paths and Drives in Granolithic, Gravel  
or Asphalt.  
Manure, Garden Soil, Ashes, &c.  
Any Suburb.

**Dentistry**  
**Dental Advice Free.**  
Dr. C. J. A. TAYLOR, formerly assistant  
to Dr. J. H. Taylor and Dr. W. L. Adams.  
Surgeon Assistant to R. H. Muir and J. H.  
Clegg, Collins Street, Melbourne. Ho-  
moeopathic to Kenneth Russell, Melbourne Ho-  
moeopathic Institute. Articled pupil of H. Hazen,  
American Dentist.  
Avail Yourself of My Experience.  
**C. J. A. TAYLOR**  
(Recorded by Dental Board, Vic.)  
268 HIGH STREET, NORTHCOTE  
(near Picture Theatre).  
Phone, Northcote 640.

Price 2d

Registered at the General Post Office, Melbourne  
for transmission by post as a Newspaper.

Saturday, June 13, 1925

Printed and published by Thomas Thomas Mott, for the Proprietors,  
D. H. Mott & Sons, at their Printing Office, 309 High Street, Northcote,  
in the State of Victoria.

**Fuel Merchants**

**RETURN TO LOWER PRICES**

Grey Box, 1ft. 2/0 13/3 2/7/- 22/13/-  
Red Box, 1ft. 2/8 13/3 2/5/6 22/10/-  
Mixed Blocks, 2/2 12/- 2/1/3 22/6 6  
1 foot 3/3 16/- 2/1/11/- 23  
Mallee Roots 2/9 13/3 2/1/6 22/11/6  
Buy your supplies during the summer  
months and save money! Crushed Oats,  
Bran, Pollard, Straw, Grain, and Poultry  
Feed of all descriptions always on hand  
in large and small quantities.  
Deliveries daily. Prices on application.

**Charles Rose**

66 ST. GEORGE'S ROAD,  
NORTHCOTE,  
Wholesale and Retail.  
Phone, Northcote 469.  
All orders left with W. McLeod, 83  
Hobham Street, Preston, will receive  
Prompt Attention.

**E. F. Blampied,**

**FUEL MERCHANT,**  
83 GLADSTONE AVENUE, NORTHCOTE.  
ON SALE:  
Wood, Coal, Coke, and Mallee Roots  
at Melbourne Prices.  
A Trial Solicited. Orders delivered to  
any address.

**John Kidd**

Intimates that his well-known  
**PRODUCE AND FUEL  
BUSINESS,**  
HIGH STREET, CROXTON,  
Will hereafter be run as  
**J. KIDD & SONS**  
(Mr. Jack Kidd, late A.I.F.)

**A. C. (Bert) HOOPER**

DESIRES to inform the Residents of  
Northcote and Preston that he  
has purchased the  
**FUEL AND FODDER BUSINESS**  
of Messrs Carling Bros., at the corner  
of St. David and Raleigh Streets,  
Thornbury.  
He trusts by civility and strict atten-  
tion to business to merit a share of  
their patronage.  
Phone N'cote 221.  
Private Address: 38 St. David Street.  
Orders may also be left with Carling &  
Sons, 489 High Street, Northcote.

**S. T. Muller,**

**WOOD, COAL AND COKE  
MERCHANT,**  
4 SMITH ST., THORNBURY  
(One door from High Street, just  
behind H. C. Dyer, Chemist).  
Best Box Blocks, Black and Brown  
Coal at Railway Prices.  
All orders promptly attended to. A  
Trial Solicited.

**Hay, Corn, Wood,  
and Coal.**

**PETER O'NEILL**

has for sale  
Chaff, Oats, Bran, Pollard, Fodder, Etc.  
Wood, Coal, Briquettes, Etc.  
443 HIGH STREET, NORTHCOTE  
(Opposite Brick Co.)

**L. A. Akers,**

**Wood, Coal and Coke  
Merchants,**  
29 DENNIS ST. & 13 DALLEY ST.,  
NORTHCOTE.  
Best Box Wood, Split Wood, Iron  
Bark, and Mallee Roots delivered at  
Melbourne Prices.  
**BRIQUETTES.**  
Orders delivered to any address.  
A Trial solicited.

**Notices.**

**ACCOMMODATION FOR WEEK-  
ENDERS.**

Tariff Moderate.  
**The Whittlesea Tea Rooms**  
(Opposite Royal Mail Hotel, Walnut St.)  
Mrs. H. RICHARDSON, Proprietress  
Lunches Provided at all Times - Hot  
Pies, Fruit and Choice Confectionery,  
Tobacco and Cigarettes.  
Dining Room Open - Three Course  
Dinner.  
Cooked Meals a Specialty.  
Hot Water Provided.  
Cool Drinks and Ice Cream.

**M. CHAPMAN**

(Late Plumbing Inspector M.M.B.W.)  
**SANITARY AND GENERAL  
PLUMBING.**  
Estimates given for House Connections,  
Plumbing and Drainage Work.  
General Repairs. Motors Fixed.  
Satisfaction Guaranteed.  
29 KEMP STREET, CROXTON.  
Phone, Northcote 1468.

**E. Weightman,**

**MOTOR CARRIER.**  
CARRIES WHAT?  
ANYTHING—EVERYTHING.  
Solicits Local Work.  
Boat, Rail, City and Suburbs.  
Fleets Attended.  
**PRELAN STREET, PRESTON.**

**Business Notices.**

Established 38 years. Phone, Northcote 1201.

**Arthur R. Bestock,**

**Wholesale and Retail  
Hay, Chaff, Straw, Grain and Seed  
Merchant,**  
481 High Street, Northcote.

**POTATOES.** Victorian Brown and Black Coal.  
**WOOD, COAL, COKE.** Mallee Roots. Clothes Lines and Props.  
**Shell Grit.** Oyster Grit. Chicken and Canary Grit.  
Agents for Clarke, King's, White & Handcock, Tyzack's,  
Chicken and Poultry Requisites, Foods, Condiments, Spices and Medicines.  
Kanswood Spices. Dog Biscuits.  
Oat Hulls, Hulled Oats, Oats, Part. Peas, Bran, Dun Peas.  
Canary, Finch, Parrot and Cockatoo Seeds.  
Malt Combing, Pollard, Mixed Grain. All kinds Vegetable Seeds.  
Pully Feed, Wheat, Growing Grain, Molasses, Wheat Screening, Growing Mash for  
Chickens, Lucerne Chaff, Maize, Laying Mash, Maize Meal, Pea Meal,  
Lupul, Barley, Barley Meal.  
Market Garden Manures, Blood and Bone Manure, Bone and Super Manure,  
Bone, Blood, Sulphate of Ammonia, Red Oil for Spraying.  
Meat Meal, Blood Meal, Bone Meal, Bovaline Eggolene, Singer's Egg Producer,  
Meyval, Festend, Vermin Killers, Drenches, Conditioner, Cures for Cough  
Cures for Horses and Cattle, Oil Cake, Calf Food, Sulphur, Salt Petre, Blue  
Stone, Resin, Gall Cures, Solomon's Solution, Rock Salt and Salt Licks, Lime,  
Cement, Axle Oils, Greases, Leather Oils and Harness Dressings, Stockholm  
Tar, Hatters, Bronzes, and Iron Handles, Whips, Poultry and Pigeon  
Rings and Log Bands, all sizes, Egg Preservatives, Twine.

**Plenty Motors Pty. Ltd.**

214 High Street, Preston,  
announce  
**BIG REDUCTIONS**  
in the prices of  
**FORD CARS AND TRUCKS.**

**MAC'S Steam Laundry,**

656 High Street, Thornbury.  
(O. Du Feu, Prop.)  
**ESTABLISHED LAUNDRETERS—NOT AGENTS.**  
Collars Ironed and Polished Perfectly and Shaped to fit  
you in comfort.  
**NOT BROKEN BY OUR NEW METHOD.**  
Dress Shirts done by us are a feature.  
Motor Coats, Curtains, Blankets, Table Cloths,  
Costumes, Quilts, Sheets,  
And EVERYTHING WASHABLE.  
Don't have the unpleasant wash day at home. We call and deliver  
any address for your household linen. Wash and iron it ready  
for use again. You save the washerwoman and firewood expense.  
Just Try it and see how Happy Home Life will be.  
Apply to us for Price List.

**Hooper's Northcote Auction Mart,**

Established 1920  
Note Address: 336 High Street  
(Opp Henderson's, Butcher).  
**General Auctioneer.**  
Sales in Rooms fortnightly—FRIDAYS at 1.30.  
Furniture, Poultry, etc., Sold on Commission. Goods also sold Privately for  
Vendors. We send our Waggon anywhere Promptly.  
Large Rooms for Display of Goods.  
**A Large List of House Properties.**  
Auction Sales of Furniture and Properties Conducted on Premises.  
**PHONE, N'COTE 946**

**W. SMITH,**

**GENERAL MOTOR CARRIER,**  
Murray Road East, Preston  
Furniture Carefully Removed to Any Suburb.  
Boat and Rail Attended. Picnic Parties Catered for.  
Phone, Northcote 923

**R. B. LAWRENCE**

**PTY. LTD.**  
Dyers, Cleaners, and  
Feather Dressers,  
Suits or Dress like New by  
Latest Process.  
Goods may be left at Office and Works: Cunningham Street, Northcote.  
Shops: Pink's Buildings, 6A Elizabeth Street (next Craig's),  
Royal Arcade, Bourke Street, and all Suburbs.  
Phone 10620, and Van will call.  
**NOTE.—WE HAVE NO SHOPS IN NORTHCOTE**

**Announcements.**

Are you building?

Let us take your  
joinery in hand

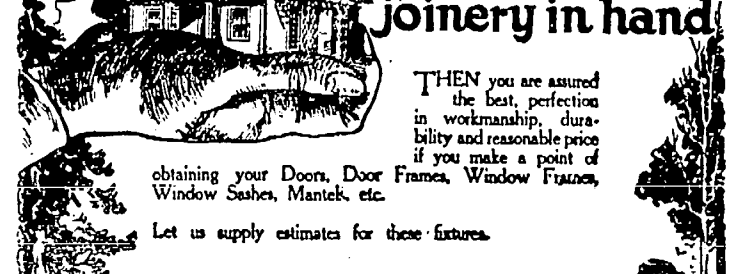

THEN you are assured  
the best perfection  
in workmanship, dura-  
bility and reasonable price  
if you make a point of  
obtaining your Doors, Door Frames, Window Frames,  
Window Sashes, Mantel, etc.  
Let us supply estimates for these fixtures.

**W. J. INGLIS PTY. LTD.**

THE PRESTON TIMBER YARD AND HARDWARE STORES.  
GLAZING AND JOINERY WORKS.  
Cr. Plenty Rd. and Osborne Grove, PRESTON  
Phones—N'cote 1209 and 757

**GRAVEL! GRAVEL! GRAVEL!**

Just What's Wanted for  
Garden Paths, Yards, and Public Highways.  
Supplied in any Quantity and at **FIRST COST**, direct from the Ruckers Hill  
Gravel Pit.  
Order Now, before the Wet Season arrives.  
Full Information at—  
**44 James Street, Northcote.**  
Letters Promptly Attended to. Phone, Northcote 776

**Nankervis & Spurr**

(Late Kellow-Falkiner),  
**Motor Engineers,**  
209-211 High Street, Northcote  
(Opposite Northcote Theatre)

All Makes of Cars Overhauled and Repaired.  
Tuning and Electrical Systems a Speciality.  
First-Class Work at a **FAIR-DEAL PRICE.**  
Full Supply of Petrol and Oil always on hand.  
**Let Us Quote You for your Next  
Engine Overhaul.**

**DAREBIN MOTORS**

"THE FIRM WHO CARES."  
Authorized Agents for—  
**CHEVROLET**  
Cars and Trucks.  
Demonstrations with pleasure.  
We have Expert Mechanics and we Specialize in Ford Repairs.  
A Complete Stock of Genuine Ford Parts and Accessories.  
So Bring Your Ford Cars to us for inspection.  
**TRY OUR MOTOR SPIRIT**  
150 gals. Sold Daily.  
Phone N'cote 1215.  
**SHOW ROOMS AND SERVICE STATION—  
96 HIGH STREET, PRESTON.**

**Be Up-to-Date and have Electric  
Light Installed in Your Home.**

Clean. No Matches. No Mantle Bills. A Pleasure to Read or Work by.  
Installations Cheaply and Promptly Executed by  
**H. P. LEE, Electrical Contractor**  
228-230 High Street, Preston.  
Every Class of Electrical Work Undertaken and Satisfaction Guaranteed.  
Phone, Northcote 103.

**T. H. NEAVAN, Farrier,**

Desires to notify the Public of Northcote, Preston, and  
surrounding districts that he has taken over the Business  
lately carried on by Mr. J. S. BURNS, at  
**417 HIGH ST., NORTHCOTE**  
(Next Corner Elm Street).  
**Full Experience. All Work Guaranteed.**

**FURNITURE**

**REMOVED  
PACKED  
OR  
STORED**  
CHEAPLY AND WITH CARE  
BY  
**Knapp & Mitchell,**  
82 Helen Street, Northcote.  
Phone, Northcote 263  
Sand, Garden Soil, Ashes and General Carting Done.

**Announcements.**

Phone, Northcote 222

**T. A. Sands,**

**Leather and Grindery Depot,**  
333 High Street, Northcote

**Boot Repairs a Speciality.**  
The Shop where you will get Full Value for Your Money.  
A Few of My Prices:  
Solid Leather School Bags, 2/- each.  
Child's Lunch Cases, 1/- each.  
Men's Solid Leather Lunch Bags, with strong lock, only 8/-  
Lovely 20in. Suit Case of Strong Fibre, 8 Vulcanite Corners  
and 2 Strong Locks, 12/6 each  
Ladies—See Our Lovely Shopping Cases from 7/6 each  
We carry a Large Selection of Globette and Solid Leather  
Attache and Suit Cases, also Ladies' and Gents' Wallets.  
Men's Leather Half Shoes, 1/- per pair  
Men's Rubber Heels, 3d pair; 6 pairs, 1/-  
Strong Boot Laces, 2d per doz.

**Artistic Home Furnishers**

PTY., LTD.  
826 High Street, Thornbury  
(Opposite Tram Terminus)  
**Complete House Furnishers**  
Manufacturers and Importers  
TERMS TO SUIT ALL.  
Good Value and Low Prices with our HIRE-PURCHASE  
SYSTEM—You get Immediate Delivery; or Buy on the  
LAY-BY and Pay before Delivery.  
**INSPECTION INVITED.**

**L. H. TADICH'S**

**MOTOR GARAGE**  
802 High Street, Northcote  
(TRAM TERMINUS).  
Authorized Sole Agent for  
**Oldsmobile Six, Jewett Cars,**  
£340 £475  
Fitted with Balloon Tyres. Standard Tourer De Luxe £254  
**CASH or TERMS.**

**CAHILL & SONS**

242 St. George's Road, Croxton.  
**Licensed Sanitary Plumbers.**  
ESTIMATES SUBMITTED. HOT WATER A SPECIALTY.  
Repairs of All Descriptions Promptly Attended to.

**Normanby Hall,**

Normanby Avenue, Thornbury  
Available for Weddings, Parties, and Dances.  
**Bell's High-Class Catering**  
either at or away from the Hall.  
Highest Satisfaction Guaranteed. Goods on Hire.

**The Northcote Red Granolithic Footpath Experts**

**A. A. FAIRWEATHER & SONS**  
(Retired Soldier).  
35-37 Herbert St., Northcote  
Footpaths, Garage Drives, Factory and Shop Floors Laid Down and Finished to  
Satisfaction.  
All Work Done by TH Guaranteed. Material & Workmanship Perfect.  
For Particulars, Ring Northcote 1747.

**Sulphate of Ammonia**

The Ideal Nitrogenous Fertilizer  
For Lawns, Flower  
and Vegetable  
Caddens.  
1/6 per pkt., contain-  
ing approx. 5 lbs.  
For Renovating  
Paths, Asphalt  
Yards, &c.  
4/- per tin, containing  
approx. 4 gallons.  
Obtainable at ALL DISTRICT DEPOTS.  
Further Particulars from the Producers,  
**The Metropolitan Gas Company,**  
198 FLINDERS ST., MELBOURNE.

**TAR**

Obtainable at ALL DISTRICT DEPOTS.  
Further Particulars from the Producers,  
**The Metropolitan Gas Company,**  
198 FLINDERS ST., MELBOURNE.

**C. J. GORDON GILLIES**

M.B.S., B.D.S.,  
Melbourne University,  
SURGEON DENTIST,  
HIGH STREET, THORNBURY  
(next Davis, Chemist).  
Hours: 9.30 a.m. to 1 p.m., 2 p.m. to 6  
Monday and Friday, 7 p.m.  
to 9 p.m.

**MR. GEORGE M. ALLEN,**

**SURGEON DENTIST,**  
Of 32 Collins Street, Melbourne,  
Announces that he has established a  
Branch of his practice at 140 High St.  
Preston South, and he may be consulted  
there every evening and on Saturdays.  
Week-day appointments must be  
made previously to ensure of prompt  
attention.  
Telephone, 11618.

**MR. J. E. ANDREA,**

L.D.S., B.D.S.,  
MELBOURNE UNIVERSITY,  
SURGEON DENTIST,  
763A HIGH STREET, THORNBURY  
(3 doors from Dyer, Chemist).  
Hours: 9 a.m. to 6 p.m. Daily.  
Monday, Wednesday, and Friday,  
7 to 9 p.m.  
Phone, Northcote 1932

**Electrical Installations**

Guaranteed All British.  
No Wood Casing. No Japanese.  
**24/- per Light.**  
**F. QUAIFE,**  
LICENSED CONTRACTOR:  
"Airlie," Collins St., PRESTON.

**Johnston & McMillan,**

**ELECTRICAL CONTRACTORS,**  
666 HIGH STREET,  
NORTHCOTE.  
Private Address:  
25 Fenwick Street, Northcote.  
And enr. Wales & Rossmoyne Sts.

**Electric Lights, Fans, Motors,  
and Anything Electric Installed.**

**REPAIRS A SPECIALITY.**

**ALL WORK GUARANTEED.**

Estimates Free. Phone—N'cote, 471.

**Bell Fibro-Plaster  
Sheets**

(All Sheets Branded).  
**MADE ALL SIZES.**  
Inspect at Factory before Ordering  
Elsewhere.  
BLANCH STREET, PRESTON  
(near Bell Station).  
Phone, Northcote 1482.

**LONDON**

**Fire Assurance.**  
You can insure your Build-  
ings, Furniture, Stocks-in-  
Trade against Fire at Lowest  
rates.  
Consult Local Agent,  
**ERNEST LEES**  
307 HIGH STREET,  
NORTHCOTE.  
Telephone, Northcote 54.

**"Rona" Dairy Farm**

Farm and Dairy:  
SPRING STREET, PRESTON.  
Pure, Fresh Milk, direct from our own  
cows, delivered twice daily in Preston  
and surrounding districts.  
Premises and Cattle under Government  
supervision.  
Our Milk is guaranteed free from  
preservatives and coloring.  
Post Cards promptly attended to.  
The favor of your patronage and re-  
commendation respectfully solicited.

**B. EDMONDS,**

**LICENSED DAIRYMAN.**  
Undertakers  
Telephone 11066.  
**H. J. R. LEWIS,**  
UNDERTAKER  
And CERTIFICATED EMBALMER,  
HIGH ST., NORTHCOTE.  
Head Office:  
Corner Johnston & Hertford Sts.,  
Hitherto.  
Funerals conducted at the low-  
est possible rates.  
Hearts, Mourning Cosesbes,  
and Funeral Requisites.  
The trade supplied.

**W. G. APPS PTY. LTD.**

UNDERTAKERS,  
MEER STREET, PRESTON.  
High and Robt Streets, St. Kilda.  
Branch: Burgundy Street, Heidelberg.  
Phone, Heidelberg 604.





WHITLESSEA SHIRE COUNCIL.

Wednesday, June 10. The usual monthly meeting was held on Wednesday. The President (Mr. B. McCann) was in the chair. There were present: Mr. W. Thomas, Mr. Brownhill, L. W. Clarke, Downie, Murphy, Funston, Reid, Hurry, Browne and Butler.

CORRESPONDENCE.

Department of Public Works, stating that under the Highways and Vehicles Act, 1920 had been made available for the half year for expenditure on traffic roads only—Received.

Mr. Browne moved that the money be spent on the main Epping road. Mr. Thomas moved that half the amount be spent in Epping and half in Whitlessea—Amendment carried.

The President moved that the members of the Epping Riding wait on the Roads Board and ask them to either to take over the Merriam road to Bourke on the Donnybrook road—Carried.

Metrodina Board of Works asking that representatives be appointed to confer with the chairman of the Board with a view to arriving at a satisfactory solution of all matters now in dispute.

Department of Public Works asking that Council confer with the Board of Works in respect to raising of the Board's watershed area. Mr. Thomas said the Board had offered the Upper Yarra Shire a generous grant if they did not join in the action, but the offer was refused.

The Council should proceed cautiously, and join up with the other Shires in Whitlessea was valued at over £17,000.

Mr. Clarke moved that a conference be called of the Shires affected. At 11.30 a.m. on June 24, and the Board be met later.

Mr. Brownhill said it was only fair to meet the Board and hold a conference afterwards.

Mr. Butler said the Council had promised to meet the Board, and later held the conference, so that a united front could be shown.

The motion was carried, and it was decided to ask the Parliamentary representatives to attend.

Department of Public Works, stating that the proposed extension of the road to T. Smith—Received.

Clear Settlement Board forwarding agreement for the extension in connection with road works at Thomastown Estate—Documents to be completed.

Municipal Association enclosing a letter from the Forests Commission stating that they had no objection to municipal council taking over the road, and sand for roads, free from State Forest reserves, but that the free issue of timber could not be granted—Received.

Cr. Thomas asked if anything further had been done with Broadmeadows Council in respect to the cost of repairs to the bridge on the Merri Creek.

After discussion the matter was referred to the council's solicitor.

Cr. Thomas asked if anything further had been done with Broadmeadows Council in respect to the cost of repairs to the bridge on the Merri Creek.

After discussion the matter was referred to the council's solicitor.

Cr. Thomas asked if anything further had been done with Broadmeadows Council in respect to the cost of repairs to the bridge on the Merri Creek.

After discussion the matter was referred to the council's solicitor.

attention. The footbridge has since been completed.

Mr. Clarke moved that a conference be called of the Shires affected. At 11.30 a.m. on June 24, and the Board be met later.

Mr. Brownhill said it was only fair to meet the Board and hold a conference afterwards.

Mr. Butler said the Council had promised to meet the Board, and later held the conference, so that a united front could be shown.

The motion was carried, and it was decided to ask the Parliamentary representatives to attend.

Department of Public Works, stating that the proposed extension of the road to T. Smith—Received.

Clear Settlement Board forwarding agreement for the extension in connection with road works at Thomastown Estate—Documents to be completed.

Municipal Association enclosing a letter from the Forests Commission stating that they had no objection to municipal council taking over the road, and sand for roads, free from State Forest reserves, but that the free issue of timber could not be granted—Received.

Cr. Thomas asked if anything further had been done with Broadmeadows Council in respect to the cost of repairs to the bridge on the Merri Creek.

After discussion the matter was referred to the council's solicitor.

Cr. Thomas asked if anything further had been done with Broadmeadows Council in respect to the cost of repairs to the bridge on the Merri Creek.

After discussion the matter was referred to the council's solicitor.

Cr. Thomas asked if anything further had been done with Broadmeadows Council in respect to the cost of repairs to the bridge on the Merri Creek.

After discussion the matter was referred to the council's solicitor.

Cr. Thomas asked if anything further had been done with Broadmeadows Council in respect to the cost of repairs to the bridge on the Merri Creek.

After discussion the matter was referred to the council's solicitor.

Cr. Thomas asked if anything further had been done with Broadmeadows Council in respect to the cost of repairs to the bridge on the Merri Creek.

After discussion the matter was referred to the council's solicitor.

Cr. Thomas asked if anything further had been done with Broadmeadows Council in respect to the cost of repairs to the bridge on the Merri Creek.

After discussion the matter was referred to the council's solicitor.

Cr. Thomas asked if anything further had been done with Broadmeadows Council in respect to the cost of repairs to the bridge on the Merri Creek.

Advertisement for Wardrop My TAILOR, And Always Will Be. Elizabeth St Melbourne (Opp PO) & at Corner Johnston & Smith Sts Collingwood. Order your Overcoat from WARDROP TO-DAY.

Order your Overcoat from WARDROP TO-DAY. Ready-to-wear or Tailored to Measure. Satisfaction Assured.

PRESTON FOOTBALL CLUB. Preston entertained Melbourne Welsh at Bell Park on Saturday last. Preston only made one change. Richards displacing McFarlane at back.

PRESTON FOOTBALL CLUB. Preston entertained Melbourne Welsh at Bell Park on Saturday last. Preston only made one change. Richards displacing McFarlane at back.

PRESTON FOOTBALL CLUB. Preston entertained Melbourne Welsh at Bell Park on Saturday last. Preston only made one change. Richards displacing McFarlane at back.

PRESTON FOOTBALL CLUB. Preston entertained Melbourne Welsh at Bell Park on Saturday last. Preston only made one change. Richards displacing McFarlane at back.

PRESTON FOOTBALL CLUB. Preston entertained Melbourne Welsh at Bell Park on Saturday last. Preston only made one change. Richards displacing McFarlane at back.

PRESTON FOOTBALL CLUB. Preston entertained Melbourne Welsh at Bell Park on Saturday last. Preston only made one change. Richards displacing McFarlane at back.

PRESTON FOOTBALL CLUB. Preston entertained Melbourne Welsh at Bell Park on Saturday last. Preston only made one change. Richards displacing McFarlane at back.

PRESTON FOOTBALL CLUB. Preston entertained Melbourne Welsh at Bell Park on Saturday last. Preston only made one change. Richards displacing McFarlane at back.

PRESTON FOOTBALL CLUB. Preston entertained Melbourne Welsh at Bell Park on Saturday last. Preston only made one change. Richards displacing McFarlane at back.

PRESTON FOOTBALL CLUB. Preston entertained Melbourne Welsh at Bell Park on Saturday last. Preston only made one change. Richards displacing McFarlane at back.

PRESTON FOOTBALL CLUB. Preston entertained Melbourne Welsh at Bell Park on Saturday last. Preston only made one change. Richards displacing McFarlane at back.

PRESTON FOOTBALL CLUB. Preston entertained Melbourne Welsh at Bell Park on Saturday last. Preston only made one change. Richards displacing McFarlane at back.

PRESTON FOOTBALL CLUB. Preston entertained Melbourne Welsh at Bell Park on Saturday last. Preston only made one change. Richards displacing McFarlane at back.

PRESTON FOOTBALL CLUB. Preston entertained Melbourne Welsh at Bell Park on Saturday last. Preston only made one change. Richards displacing McFarlane at back.

PRESTON FOOTBALL CLUB. Preston entertained Melbourne Welsh at Bell Park on Saturday last. Preston only made one change. Richards displacing McFarlane at back.

Advertisement for Robertson & Jones, Real Estate Agents. Subdivisional Land Specialists. Estate & Insurance Agents, Farm Salesmen. Expert Rent Collectors.

Advertisement for Preston Municipal Elections, West Ward. Cr. Llewellyn Jones, J.P. Polling Day: August 27th.

Advertisement for Arthurton Road and District Progress Association. Arthurton Road and District Progress Association.

Advertisement for Church of Epiphany. Church of Epiphany. Concert and Tea Meeting.

Advertisement for Preston Ladies Benevolent Society. Preston Ladies Benevolent Society. Grand Concert.

Advertisement for Preston Ladies Benevolent Society. Preston Ladies Benevolent Society. Grand Concert.

Advertisement for Preston Ladies Benevolent Society. Preston Ladies Benevolent Society. Grand Concert.

Advertisement for Preston Ladies Benevolent Society. Preston Ladies Benevolent Society. Grand Concert.

Advertisement for Preston Ladies Benevolent Society. Preston Ladies Benevolent Society. Grand Concert.

Advertisement for Surplus Stock Reducing SALE. Next Thursday, Friday, & Saturday at Leeden & Bock's, Northcote's Busy Drapers. Every Article in our Store Reduced for this Week-end.

Advertisement for Educational. Westleigh College, Bayview St., Northcote. Principals Miss Gresham, Miss Rayment.

Advertisement for Educational. Miss Eileen Pascoe-Webbe, M. Teacher of Refined Juvenile Etiquette, Singing, Dancing and Elocution.

Advertisement for Educational. Miss Marion Hay, A.L.C.M., Teacher of Elocution. Pupils prepared for Examinations and Certificates if desired.

Advertisement for Educational. Miss RENE SEARLE, Late with Miss Wallis, Helen Street, wishes to notify Patrons that she is carrying on the business at 15 CAMPBELL GVE., NORTHCOTE.

Advertisement for Your Winter Suit. HAVE IT "SHANDS" TAILORED. Many New and Attractive Patterns are offered in our showing of winter suits.

Advertisement for At "MASSON'S" CHEAP PAINT. Quality 1 1s 6d Gallon. Ready Mixed. Having Purchased an Entire Stock, we are passing on our Bargain at these Ridiculous Prices.

Advertisement for Do Not Miss This Opportunity. "MASSON'S" Hardware Merchants. Leaded Light Manufacturers. 252 High Street, Northcote.

MONEY! MONEY! Why go Short of a £ or Two when you can get a Loan from £3 Upwards... JAS. ALLAN, 391 High Street, Northcote.

FOOTBALL The King of Australian Sport. S.S.C. MATCH II SPECIAL. The SEASON is here. Let us assist you in the task of Selection of Jerseys, Knickerbockers, Boots, Balls, and all Sundries...

The World-Renowned Overland Service Station for Northcote & Preston. EDWARD B. SCOTT, Engineer, Cnr. Shaftesbury Parade and Leinster Grove, Northcote.

Clifton Motor Garage, 212 Queen's Parade, Clifton Hill. Taxis and Touring Cars for Hire Day or Night. All kinds of Repairs and Overhauling Done at Cheapest Rates.

PAINLESS DENTISTRY. J. W. BLITZ, Surgeon Dentist, 244 High St., Northcote. All the Most Up-to-Date Methods of Dentistry, including Crown and Bridge Work.

Maie Lenne, Cutter and Designer of Latest American and Parisian Costumes. Own Materials Made Up. Smart Tweeds in Cinnamon and Brown, from £7 7s.

Meet Health Every Day! The Purest and Most Nourishing of All Drinks for the Invalid as well as for the Healthy... F. Lanteri's Pure Australian Wines.

F. LANTERI, Wine Merchant, 812-814 High Street, Upper Northcote.

Commercial and General PRINTING ORDERS. Executed to Your Satisfaction at the "Leader" Office, Northcote. Phone, Northcote 46.

PRESTON TOWN COUNCIL. TUESDAY, JUNE 9th.

Present: The Mayor (Mr. J. W. Adams), Councillors (Messrs. J. Bransgrove, Jones, and McPherson). CORRESPONDENCE. From Hon. J. Cain, M.L.A., stating he would keep in view the proposed erection of the Court House...

Public Health Department, enclosing copies of proposed Common Lodging House Regulations. Received, and referred to the committee of the whole council.

Committee of the whole council. Mr. C. T. Crisp moved that the accounts amounting to £1111/11/3 be approved. Adopted.

Mr. C. T. Crisp moved that the accounts amounting to £1111/11/3 be approved. Adopted. (In liquidation) asking for a refund of deposit of £2000.

Mr. C. T. Crisp moved that the accounts amounting to £1111/11/3 be approved. Adopted. From Hon. J. Cain, M.L.A., stating he would keep in view the proposed erection of the Court House...

Mr. C. T. Crisp moved that the accounts amounting to £1111/11/3 be approved. Adopted. From Hon. J. Cain, M.L.A., stating he would keep in view the proposed erection of the Court House...

Mr. C. T. Crisp moved that the accounts amounting to £1111/11/3 be approved. Adopted. From Hon. J. Cain, M.L.A., stating he would keep in view the proposed erection of the Court House...

Mr. C. T. Crisp moved that the accounts amounting to £1111/11/3 be approved. Adopted. From Hon. J. Cain, M.L.A., stating he would keep in view the proposed erection of the Court House...

Milady's Corner. By MOTHER MEG. SPRING FOOTWEAR.

There is a spring motion just to a few of you in the present weather. Cretonne shoes are to be the rage in the place of white shoes...

By the way, in consequence of the prevailing taste for short skirts, Queen Mary has asked that dresses at the coming Courts shall be much shorter.

PICKLED MUSHROOMS. First boil the mushrooms lightly in salted water, then wash them and move the stems and wash them with salt.

VEGETABLE MARROW CHUTNEY. Two lbs. marrow, 1 large onion, 3 pint vinegar, 3 oz. ground ginger, 2 oz. sugar, 1 oz. chopped chillies, 4 oz. raisins, 1/2 lb. brown sugar.

A PARTY THICK. It is fun at parties to be able to do little thought-reading tricks, and here is a very easy one.

WANTED TO BUY. BOTTLES, Bones, Hags, Zinc Lead, Brass and Copper. Highest price given. Cash on delivery.

WANTED TO BUY. FURNITURE OF ALL KINDS. In Large or Small Quantities. Top Prices Given.

WANTED TO BUY. G.O.W.L.E. Good Quality Commission. Ding Dong. Giltie. Re-Registered.

Music. MISS RUBY GROVES, L.A.B. Associated Board R.A.M., R.C.M.

MISS RUBY GROVES, L.A.B. Associated Board R.A.M., R.C.M. Pianoforte, Theory, Singing, 20 Amberley Grove, Northcote.

MISS E. P. RAE, Registered Teacher of Music. Associate of the London College of Music.

MISS G. M. JOHN, A.L.C.M., Teacher of PIANOFORTE, THEORY AND HARMONY. Certificates from University Conservatorium.

MISS MURIEL THOMAS, Grad. Grad. Honors, L.A.B., (Highest Marks in Australia for 1924).

MISS VIOLET GROVES, L.A.B., L.T.C.L., L.C.M. Teacher of PIANO, THEORY, and PIANO SUCCESSFULLY PREPARED FOR EXAMS. and Competitions.

MISS D. SEYMOUR (Contractor). TEACHER OF PIANO & SINGING. Latest and Most Complete Methods of Voice Production.

MISS THELMA BENNETT, A.L.C.M., PIANIST. Certificates from University Conservatorium and London and Trinity College Gold Medalist.

J. CALDER, Practical Gardener. GARDENS LAID OUT AND ATTENDED. Contract or Day Work.

Estate and Insurance Agents. ERNEST LEES.

ERNEST LEES, 307 HIGH ST., NORTHCOTE, (Opposite National Bank). Estate and Commission Agent and Sworn Valuator.

NURSE HOOPER "LILLIEVILLE" PRIVATE HOSPITAL. Darsburg Northcote, Certified Nurses and Maternity Medical and Surgical Nurse available for Out-patient Practice.

NURSE GILCHRIST "Colchester" Private Hospital Ladies Northcote, has Vacancy Nurses and Midwifery cases received.

MISS MURIEL THOMAS, Grad. Grad. Honors, L.A.B., (Highest Marks in Australia for 1924).

WASH BROS. Furniture Warehouse at 792 High Street, Thornbury.

W. L. L. M. S., 19 CUNNINGHAM STREET, SOUTH NORTHCOTE. Has returned from Tour and is Enrolling New Pupils.

W. L. L. M. S., 19 CUNNINGHAM STREET, SOUTH NORTHCOTE. Has returned from Tour and is Enrolling New Pupils.

W. L. L. M. S., 19 CUNNINGHAM STREET, SOUTH NORTHCOTE. Has returned from Tour and is Enrolling New Pupils.

Notices

J. W. MOUNSEY, Fuel and Fodder Merchant. 370-386 High Street, NORTHCOTE. All Classes of Fuel Kept in Stock. Phone, Northcote 1454

SEE THE DISPLAY IN AUTUMN HATS at the RENE MILLINERY PARLORS, High St., Northcote (cnr. Beaver's Road). Mrs. D. GREEN, Proprietress.

The Right Place to Buy the Right Gifts. JEWELLERY is the Gift of Gifts... Wm. Thackray 113 HIGH STREET Northcote

PAINT AT PRIDGEON'S White and Colors at 17/6 gallon. DURALENE PAINT. Pridgeon's Paint and Paper Store, 391 High Street, Northcote

I Strike the Happy Medium In Dental Charges. I don't go to one extreme and charge an absurdly low price for obviously "cheap teeth"... Rolyat Teeth. C. J. A. Taylor

DRUNK IN CHARGE OF CAR.

ONE MONTH AND 5s.

At the Preston Police Court on Thursday before Mr. Macnamara, P.M., and Messrs. Elson and Lewis, J.P.s, James Alfred Edwards, St. David street, Northcote, was charged with no reply to the influence of drink on Epping road, near Waller's. A further charge was driving a motor car in a manner dangerous to the public was also heard.

Inspector Anwarah prosecuted. Defendant pleaded not guilty to each charge. Stanford Bluntish, tramway employee, of Northcote, said at 6.15 on April 10 he was driving a motor cycle with a side car near Waller's. Witness was on his left side of the road, travelling at about 15 miles per hour. Mr. Murray was in the side car and his son was on the back. Near the Waller's church he felt a crash on the back of his bike, causing witness to be thrown on to his head on the road, and he was rendered unconscious. He did not hear any horn blown. The only other traffic on the road were three cyclists in front. Witness had been in hospital for eight days.

Cross-examined, witness denied that he had ever been in an accident before. He had never had anyone on the back of the cycle before. The person on the back would cling hold of witness or of the side car. It was daylight. The push bikes were about 100 yards ahead. Alfred George Murray, male, said he was in Barnett's side car on April 10 at about 6.10 p.m. on the Epping road, near Albert street, when he saw something crash into the cycle, and the cycle ran into a stone wall on the side of the road. When he looked round witness's son was picking himself up off the road. Bluntish was unconcerned. He saw the car which had struck them about 100 yards ahead. Defendant and defendant and a companion were walking back. Witness said to Edwards "You're drunk" and Edwards made no reply. Edwards said he blew his horn, and later said his tyre blew out. There were two other men in the car, and both were drunk. Prior to the accident the motor cycle had passed the car about a mile back, and the occupants were drinking out of a bottle. After the accident defendant's car passed at about 30 miles per hour, and travelled about 120 yards before it stopped. Defendant could not stand straight, and witness came to the conclusion that he was under the influence of drink and fit to drive a motor car. He appeared muddled.

George Murray, son of the last witness, said he was sitting on the back of the cycle, and he first noticed defendant's car when it was about 30 yds. distant, and zig-zagging across the road and travelling at a fast pace. Shortly afterwards the car hit the motor bicycle. The car proceeded about 200 yards before stopping. Defendant and another man got out and they appeared to be drunk and were wobbling about. H. C. Dyer, chemist of High street, Thornbury, said on Good Friday, he was going to Epping and was by Murray, and gave attention to Bluntish who had been injured. Edwards admitted he was driving the car, and he appeared to be under the influence of liquor.

To Mr. Barnett: A man's nerves could be shaken by a motor accident. To the P.M.: Defendant was not so drunk that he could not stand. George William Alexander said on Good Friday he was with the last witness. Alfred Rowe, a cyclist, said Edwards appeared to be sober. From the traces the outfit appeared to be on the metal track. The car travelled about 150 yards after the accident. Frank L. Rowe said after the accident the car was travelling about 10 m.p.h. James Alfred Edwards said on April 10, he gave two men, who were drunk, a lift to Epping. Near the church at Waller's he saw a motor cycle and side car, and when near their front tyre blew out, and he had to steady the car down or it would have turned over. Witness did not know that he struck the cycle. Upon returning to his car he began to repair the tyre when George Murray came along. He denied being drunk. Edwin Norman Hale said he went to Epping with Edwards, and at Bell street invited two friends, who had "had a few," to ride with them. Just before they got to the cycle they saw a bang, and the front wheel was found to be punctured.

Thus, R. Dyer, of Daresburg Motors, said on the night of April 10, he put a new tube in the tyre of Edward's car. He was sober. Defendant was sentenced to one month's imprisonment, on the first charge, and fined 5s with 2s/18s costs on the second. A stay of proceedings for 28 days was granted.

SEALS WONDERFUL NOSES. TRAP-DOORS THAT KEEP OUT SAND AND WATER.

Most of us when we go in for diving have the very unpleasant experience of getting our nostrils full of water. Nature did not design man to be a diving animal, otherwise she would have been as clever with his nose as she has been with the seal's. The seal is, without doubt, the cleverest diver in the animal world, and his nose is a very ingenious contrivance indeed. Each nostril is provided with muscles which close it hermetically at the owner's will. And the shape of the nostril is such that when the nostrils are closed not a drop of water can enter.

With seals the closing of the nostrils at the moment of diving has become an automatic process. This is wonderful enough, but we can see a still more remarkable application of the same principle in an animal as far removed from the seal as a shark is from a chameleon. The seal is a water animal. The chameleon is an inhabitant of the driest parts of the world, the waterless, sandy deserts.

Now why should the camel require such an apparatus? He is not troubled with water, but he is troubled with dust, and the dust that we see in this country, but the fierce, blinding dust storms of the desert. These are so violent that tiny particles are driven into the works of even the most finely-adjusted watch, which becomes at once clogged and useless. If the camel had not nostrils which were perfectly dust-tight, he could never endure the dreadful sand and dust storms.

Advertisement for Mr. W. P. Riordan, Dentist, 110 Collins Street, Melbourne. Also advertisement for W. G. L. E. Y. Painter, Paperhanger and House Decorator, 2 Northcote Street, Northcote.

WIRELESS. By R. J. COLLINS.

A THREE VALVE RECEIVER. Most people who intend to install wireless receiving sets are confounded by the dozens of different circuits which appear in various Wireless Journals each week. As was stated in last week's article, there are only about eight fundamental circuits and these by careful elimination can be brought down to one or two circuits peculiarly adapted to our broadcasting. Of these the cheapest and most satisfactory set for a person desirous of hearing the latest broadcasting on a loud speaker, and all other Australian broadcasting stations with good phone strength is the three valve regenerative circuit which we will now describe.

- COMPONENTS. 3 UV 201A valves... £3 7 6. 2 Crosley Tube Sockets... 9 0. 1 Ebonite Panel, 18 in. by 6 in. (best English)... 6 0. 1 Ebonite Panel, 12 in. by 6 in. (best English)... 3 0. 1 Brunet Amplifier... 2 2 0. 1 Pilot Battery... 1 10 0. 1 Polar Two Coil holder... 10 6. 1 Ormond .001 variable condenser... 16 6. 1 Set engraved terminals... 3 3. 1 W & M grid condenser (.0005 mfd) and grid leak (2 meg)... 3 3. 1 W & M Bypass condenser .001 mfd... 1 8. 1 Set engraved terminals... 3 3. 2 Pilot double circuit jacks... 6 0. 1 Pilot single circuit jack... 2 6. 1 Frost Battery switch... 3 0. 6 Coils 25, 50, 75, 100, 150 (Duo-lateral)... 8 11. 6 Flange Coil Mounts... 10 0. 6 Lengths coil mounting (best English)... 1 0. 1 Helicon 60 volt high tension battery... 15 0. 18 Lengths bus bar (tin-plated 2 ft. lengths)... 3 0. 3 Yards Spaggetti sleeving... 1 10 3. 1 CAV 6 volt 55 ampere car battery... 5 17 6. 1 pair Brunet 'phones, type "Pir"... 1 5 0. 2 Pilot plugs... 1 5 0. 2 Nickel contact studs... 1 5 0. 2 Battery clips... 2 6. 4 Yards solid rubber covered flex... 1 5 0. £19 1 6.

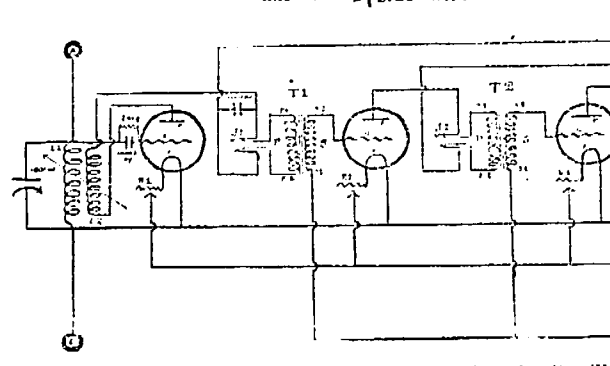

The wiring diagram gives a clearer idea of the wiring used in this set than a diagram in which the components are shown pictorially. The two coils L1 and L2 are mounted on the Polar two coil holder, and the left hand or fixed coil the aerial inductance, while the right hand or moving coil is used for reaction. In parallel with the aerial inductance (the tuning condenser, Ormond .001 mfd variable condenser with vernier being very suitable. This condenser must have a vernier, or difficulty will be experienced in tuning in the distant stations. A W & M grid leak and condenser is connected between the aerial terminal and the grid of the detector tube, and it should consist of a 2 megohm resistance and a .0005 mfd fixed condenser.

A .001 mfd bypass condenser is bridged across the two outer leaves of the first Jack, J1, in order to allow the high frequency currents flowing in the plate circuit an easy path, instead of flowing through the high inductive reactance of the 'phones or the primary of the transformer. The method of connecting the primary of the transformer T1 to the inner leaves of the Jack J1 is shown in the diagram. The plate current flowing from the terminal P1 (the "P" plus Det.) to the bottom outside leaf of J1, through the bottom inside leaf to the terminal P2, and the other end of the transformer, from the P1 terminal on the transformer to the inner top leaf of the Jack to the top leaf, and then through the reactance coil L2 to the plate.

From the terminal on the first transformer marked S2 a wire goes to the grid of the second valve, and from S1 to the "C" terminal. The connections of the second transformer are similar in every respect to T1, except of course that there is no reaction coil, and the wire from the bottom leaf of J2 goes to a separate high tension terminal, H, instead of to the grid of the second valve. It is not in the least like any of the natural sugars in structure, although it is composed of the same elements—carbon, hydrogen, and oxygen, the common elements of all foods. The same number of atoms of the same elements, attached to one another in the same way, are arranged in a slightly different position, the resulting compound is not sweet at all.

A SUBSTITUTE FOR SUGAR. WIRELESS.

If you find that you have to order sugar more frequently than you like, buy a pound of alpha-sulfate of calcium. This single pound will go as far as a ton of common sugar. It is made from the oil of a plant known to the Japanese as "Shio" and to the botanist as "Porphyra," and is two thousand times sweeter than sugar. It is not in the least like any of the natural sugars in structure, although it is composed of the same elements—carbon, hydrogen, and oxygen, the common elements of all foods. The same number of atoms of the same elements, attached to one another in the same way, are arranged in a slightly different position, the resulting compound is not sweet at all.

Advertisement for Miss Turner, 151 Shaftesbury Parade, Croxton. Also advertisement for W. G. L. E. Y. Painter, Paperhanger and House Decorator, 2 Northcote Street, Northcote.

Business Announcements.

SWITCH ON Radiators and Keep the Cold Out. Look at This: The Northcote, 45/- The Thornbury, 49/6. These Radiators are Locally Made and are made to give Satisfaction and Service. Large Stocks of other Lines from 32/6. E. W. BRIGHTON, Electrical Engineer and Contractor. Tram Terminus, 820 High Street, Thornbury.

LIGHTS. MOTORS. ANYTHING ELECTRICAL INSTALLED. BATTERIES BOUGHT AND CHARGED.

RADION ELECTRIC COY. Radiators a Speciality Radio Parts of Every Quality. Our Address is 241 High Street, NORTHCOTE.

WE CATER FOR ALL. ELECTRIC IRONS, from 21/- to 42/-. RADIATORS, from 37/6 to 158/6. Headphones, 17/6. Any Article may be Bought on the Lay-by System.

All Classes of Electrical Engineering. Every Kind of Lighting Installations Done. Up-to-date Battery Charger.

Whittlesea Motor Garage. Authorised Ford Dealer for the District. Standard Towner, D.S. & S.S., with Self-Starters, £179/10/-.

La Vinnette Toilet Parlors. 113 High Street, Northcote South. Latest Hair Cuts, Treatments, Dyeing, Singeing, Manicuring, Etc.

XMAS 1925. Look Ahead! Your Calendars. "LEADER" OFFICE, 309 High Street, Northcote. D. H. MOTT & SONS, Proprietors.

MADDOCK, JAMIESON, AND LONIE, SOLICITORS AND CONVEYANCERS, 186 and 188 Queen Street (between Bourke and Little Collins Streets), Melbourne.

MADDEN, DRAKE & CANDY SOLICITORS & CONVEYANCERS "THE OLDFLEET" (First Floor), No. 476 COLLINS STREET. Telephone, Central 186.

HOME AND WILKINSON, SOLICITORS, CONVEYANCERS, &c. Commercial Union Chambers, 418 Collins Street, Melbourne.

W. R. VALE BARRISTER & SOLICITOR, CONVEYANCER & PROCTOR, 443 CHANCERY LANE, MELB.

FRANK BRANNAN & CO. SOLICITORS, Yorkshire House, 20 Queen St., Melbourne. Trust Money Awaiting Investment. Tel: 7697, 7088.

NICHOLAS O'DONOHUE, BARRISTER AND SOLICITOR, may be consulted any evening at his Residence, 783 HIGH STREET, THORNBURY.

STOP! Car for Hire. LUXURIOUS 7-PASSENGER BARLEY SIX DAY OR NIGHT WEEK-END TRIPS A SPECIALTY.

CARS FOR HIRE. LATEST SIX-CYLINDER TOURING CARS. REDUCED RATES. PICNICS, RACES, SPORTING PARTIES CATERED FOR.

Ring Northcote 1302 116 Westbourne Grove. SMITH & CULLEN, SIGNWRITERS, 77 PENDEEN STREET, NORTHCOTE.

MONEY FOR PRIVATE LOANS. Any Married Lady or Person in Constant Work can obtain a Loan of £3, £5, £10 Upwards. At a Private Home, Without Security. Low Interest, and Small Weekly or Fortnightly Repayments. Absolute Privacy Guaranteed. Call, Write or Phone N'cote 854. JAMES SMITH, 42 GORDON GROVE, NORTHCOTE (Near Merri Station). Hours: 9 a.m. to 9 p.m. Saturdays, 9 a.m. to 1 p.m.

Business Notices

Westgarth Dentistry, 80 HIGH STREET, WESTGARTH.

(Late Mr. McKerrlie's). FOR MODERN UP-TO-DATE DENTISTRY. Extractions Absolutely Painless. Country Patients will receive Prompt Attention and their work done on shortest notice.

COLD WEATHER MEANS WARM HOUSES.

ROBERTSON & O'DONNELL, 463 HIGH STREET, NORTHCOLE.

RADIATORS

We have now a Stock of Beautifully Made Radiators in the New Old-Gold and Oxidized Copper Finish, suitable for any home or office.

We are Quoting a Few of our Special Lines: "Perfex" Heats Fire in Reflector, 1000 w. \$22.00 "Orion" " " " " " " " " 1000 w. \$22.00

G. DALGLEISH, Watchmaker and Jeweller.

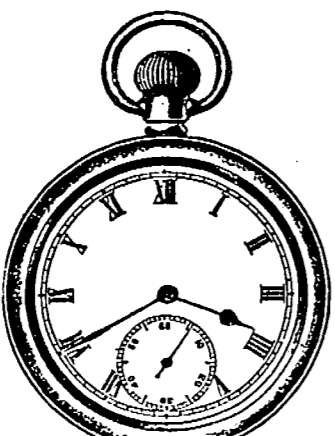

We guarantee the Watches here advertised to be the Best Value obtainable, and made by the world's leading factories.

Table with 3 columns: 1st, 2nd, 3rd. Lists watch models and prices.

You Cannot Buy Better Watches Cheaper. We guarantee Perfect Satisfaction with each of these watches. We Specialise in Wedding Gifts.

The GRAMAPHONE A Modern Miracle.

The Gramophone has become almost a commonplace, yet it is not by what it achieves, something of a miracle? In the world of music the two supreme artists of the last century were Jenny Lind (the Swedish Nightingale) and Paganini—the one a greatly gifted singer, the other a wizard of the violin.

New Trading Agency Pty. Ltd. Have transferred their Parlours, on a Very Much Enlarged Scale from 751 High Street, Thornbury, to 273 High Street, Northcote.

MISS WINTER, Milliner and Ladies' Draper.

The HOME of MILLINERY

Berlei, the Australian Made, Naturally Fitting Corsets, Wrap-ons and Brassieres, also D. & A., W. B., Nautilus, Lady Ruth, Youth Line Redusa, etc., etc.

"ECONOMIST" GAS COOKING STOVES. With Cast Iron Patent Casings and Porcelain Enamel Tray. Separate Oven and Heater. Will Toast, Roast, Bake, Grill, &c.

FOOTBALL

Northcote defeat Williamstown

VISITORS OUTPLAYED.

Gough Kicks Seven Goals.

At the neighbouring League teams were not playing last Saturday it was thought that a large crowd would have assembled at the Northcote Park to witness the first encounter of the season between Northcote and Williamstown.

Williamstown, 4 goals 7 behinds (31 points). As the wind had dropped, neither side had an advantage. Williamstown opened the attack, Wilkins scoring a goal. Gough equalised the performance by running in and scoring a goal. Defending well, the visitors held the lead from scoring. Gough followed by running in and scoring a goal.

Northcote, 15 goals 15 behinds (123 points). Williamstown, 8 goals 7 behinds (58 points). The display of the locals was very pleasing to the supporters. Systematic forward work coupled with clever centre play were the strong features of the side, while the back work was very thorough.

Northcote opened the second quarter with a brilliant systematic attack. The visitors had scored 2 goals, but Northcote scored 3 goals. Gough kicked a drop-kick and the sixer. The locals were dominating the back, Goodrick, Sheehy, and Theobald doing an immense amount of work.

Northcote, 9 goals 5 behinds (59 points). Williamstown, 3 goals 4 behinds (22 points). With a deficiency of 37 points, the visitors began their upturn by attacking vigorously. From a penalty kick, Smith scored his second goal. Their supremacy, however, was short-lived.

TO-DAY'S MATCH. Northcote play Coburg, to-day, at Coleridge. A great game is anticipated, Johnson and Anderson have both commenced training again. McNeil, who was out of the team last season, is now fit to play.

Preston Get Home on the Death Knock.

RESOURCEFUL "BUTCHER" OGDEN.

Stirring and Exciting Finish. Considerable interest was evinced in the meeting of Yarraville (undefeated) and Preston (who have suffered one defeat) in the derby last Saturday. There was a fair number of spectators and the teams appeared on the arena looking fit and anxious to engage in the ordeal which awaited them.

Yarraville—Forwards—Warr, Moffatt, Power, half-forwards—Timothee, Thorpe, Bart; centres—Ogden, Deacon, Summers; half-backs—Robertson, Aker, Burton; full-backs—Graham, Griffith, followers—Stevens and Torode; rover—Skippier.

Yarraville—Forwards—Holt, Kennedy, Shields; half-forwards—Morgan, Joyce, Powell; half-backs—Barton, C. Leo, Smith; backs—Malberg, Mitchell, Knott; rover—Woodman.

This was the first game in which the new rule of deliberately punching the ball was put into operation, and it was some little time before both sides could reconcile themselves to it, and, naturally, many free-kicks

were given before the players settled down. Yarraville were the first to have a warning, but their first free-kick was a warning shot.

Yarraville came away by the pavilion wing, but coming in contact with Deacon, the rules he was awarded a penalty kick and returned the play where Power, on receiving a free, only managed a behind well within the goal.

Preston—3 goals 6 behinds (18 points). Yarraville—1 goal 2 behinds (8 points). Preston immediately attacked on resuming, Moffatt, from a nice place, kicking a sixer. Yarraville replied by kicking a sixer, but O'Brien responded by punting a major point for the visitors. Thorpe passed only, and took the advantage of the mistake and materially added to their score.

Preston, 3 goals 12 behinds (30 points). Yarraville, 5 goals 4 behinds (34 points). With 4 points to the bad Preston attacked, led by Ogden, who kicked a goal, but was returned by O'Brien. Yarraville defended and forwarded where Aker returned and Thorpe assisted in Stevens securing a goal from the ruck.

Yarraville, 5 goals 4 behinds (34 points). Northcote, 4 goals 2 behinds (26 points). Williamstown, 2 goals 4 behinds (10 points). Northcote opened the second quarter with a brilliant systematic attack. The visitors had scored 2 goals, but Northcote scored 3 goals.

Northcote, 9 goals 5 behinds (59 points). Williamstown, 3 goals 4 behinds (22 points). With a deficiency of 37 points, the visitors began their upturn by attacking vigorously. From a penalty kick, Smith scored his second goal.

TO-DAY'S MATCH. Northcote play Coburg, to-day, at Coleridge. A great game is anticipated, Johnson and Anderson have both commenced training again. McNeil, who was out of the team last season, is now fit to play.

Whittlesea and Other Matches.

On Saturday last Whittlesea journeyed to Hurstbridge where they met the "Hicks" and secured a good game. Whittlesea won with five points to spare.

On Saturday last Whittlesea journeyed to Hurstbridge where they met the "Hicks" and secured a good game. Whittlesea won with five points to spare. The game was fairly open, with the exception of the last quarter which was very crowded.

On Saturday last Whittlesea journeyed to Hurstbridge where they met the "Hicks" and secured a good game. Whittlesea won with five points to spare. The game was fairly open, with the exception of the last quarter which was very crowded.

K.S.P. COMPETITION. AN OPPORTUNE TIME.

South Preston Methodists were visitors to Northcote where a fast even game for the first three quarters was witnessed. At the end of the third quarter the scores were equal, but the fourth served to see South Preston predominating the play, running out easy winners by scoring 12 goals 13 behinds to 6 goals 9 behinds.

"Dreams of Long Ago!" tender memories, Whispers fond and low, haunting melodies, Love songs sweetly and stirring to and fro, Echoes of the past—"Dreams of Long Ago!" Ripples on the tide "neath a light subline, Tender words which bid thro' the flight of time, Childhood's tears and dread when we group endure, And with Wood's Great Peppermint Cure.

Residents of Thomastown, Epping, Woollert, Woodstock, and Surrounding Districts. BEASLEY'S Rapid Boot Repairs. Edwardes Street, RESERVOIR.

JENKINS & CO., 465 HIGH STREET, NORTHCOLE. Blue Star Garage. Proprietors: C. E. JENKINS, E. MGN. ROBERTSON, District Agents: (late Talbot Factory, England). District Agents: "Crosley" Cars, A.E.C. Motor Lorries, and Tipping Trucks.

Special Bedding FOR THIS WEEK

4ft. 6in. Well-filled Mattress, Bolster, and Two Pillows (Complete Set) 32s 6d Plain or Fancy Ticking.

D. K. ROSS'S FURNITURE STORES, 199, 201, 203, 205 St. George's Rd., North Fitzroy.

A STANDARD OF PURITY. The Bread we sell is made under conditions ensuring its perfect purity and a standard of excellence which no other bread offered to the public has attained. BREAD is such an important factor in your daily diet that it becomes you to purchase the best. Lot us supply you every day. CALLANDER, The Better Baker. PRESTON AND HEIDELBERG. Phones: Northcote 40, Heidelberg 66.

The Croxton Paint, Oil & Paper Store. 612 HIGH ST., CROXTON. (Close to Martin Street and Tram Sheds). Phone, N'cote 649. A Large Assortment of General Trade Materials Always in Stock. Agents for Berger's and the Acas Ready Mixed Paints. Estimates Given for General House Repairs of all Kinds. McEntee & Poole.





WHITTLESEA SHIRE NEWS.

WHITTLESEA SHIRE NEWS. The hunting season now in full swing is noticeable...

SOUTH PRESTON STATE SCHOOL. PROPOSED JUBILEE FETE.

SOUTH PRESTON STATE SCHOOL. On Wednesday evening a somewhat informal meeting was held...

PERSONAL.

PERSONAL. The Northcote Diggers have honored Mr. Bob Kaynor...

E. J. CALLANDER'S EMPLOYEES. SECOND ANNUAL SOCIAL.

E. J. CALLANDER'S EMPLOYEES. At the invitation of Mr. E. J. Callander and employees...

Real Estate Agents. Robertson & Jones.

ROBERTSON & JONES. (LLEWELLYN JONES, Auctioneer and Sworn Valuator.)

PRESTON MUNICIPAL ELECTIONS. WEST WARD.

PRESTON MUNICIPAL ELECTIONS. WEST WARD. Cr. Llewellyn Jones, J.P., Solicitor your Support and Influence.

Polling Day: August 27th.

Polling Day: August 27th. He Represents no Party or Section, but the whole of the Ratepayers.

Preston Anglers' Club.

PRESTON ANGLERS' CLUB. Last week-end eight anglers, members of the above club, visited Mordulloo for the purpose of indulging in fly fishing.

Dancing for Charity. BRILLIANT FUNCTION AT PRESTON.

Dancing for Charity. BRILLIANT FUNCTION AT PRESTON. On Thursday evening the Preston Town Hall was on fire, the occasion being a dance for the Ladies' Benevolent Society.

Princes of Wales' Park Methodist Church Brotherhood.

Princes of Wales' Park Methodist Church Brotherhood. The above held their first quarterly social on Monday evening, it proving a great success, between 40 and 50 men assembled...

Social Evening.

social evening. On Thursday, June 11th, a very enjoyable evening was given by Mr. and Mrs. James Bell, Normanby Hall, Thornbury.

Stott, Son, and Watson.

STOTT, SON, AND WATSON. Phone: Northcote 479 and 564.

Why not Now?

Why not Now? GET A LIST FROM Stott, Son, and Watson.

Northcote Municipal Concert.

NORTHCOTE MUNICIPAL CONCERT. A fine Municipal Concert, the second of a series given by the Mayor of Northcote...

Northcote Branch A.N.A.

NORTHCOTE BRANCH A.N.A. Some thirty odd members of the club took part in a "welly welly" tournament last Saturday afternoon.

Church News.

CHURCH NEWS. On Sunday evening a special musical and song service will be held at the High Street Methodist Church, when a varied programme of sacred songs will be arranged by the conductor, Mr. Bart Cox.

Caufield to-day.

CAULFIELD TO-DAY. Hurdle, Thompson, Rabah, Borriello, and others participated in the annual hurdle race on Saturday morning...

Property Sales.

PROPERTY SALES. Mr. and Mrs. Deane, on Saturday (17th), at 10 o'clock, on the property, 41 Shaftesbury Parade, Croxton, will offer W. H. Villa.

Money for Private Loans.

MONEY FOR PRIVATE LOANS. Any Married Lady or Person in Constant Work can obtain a Loan of £3, £5, £10 Upwards.

James Smith.

JAMES SMITH. 42 GORDON GROVE NORTHCOTE. (Near Morris Station). Hours: 9 a.m. to 9 p.m. Saturdays, 9 a.m. to 1 p.m.

Business Announcements.

Surplus Stock Reducing SALE. NEXT Thursday, Friday, & Saturday at LEEDEN & BOCK'S, Northcote's Busy Drapers.

Northcote Library.

NORTHCOTE LIBRARY. All Privileges Absolutely Free to Patrons and Residents.

Wanted to Buy.

WANTED TO BUY. BOTTLES, Bones, Rags, Zinc Lead, Brass and Copper.

Wanted to Buy.

WANTED TO BUY. FURNITURE, Paints, etc. is Best Sold at HOOPER'S NORTHCOTE AUCTION ROOMS.

Wanted to Buy.

WANTED TO BUY. STERLING SOAP COMPANY. SOUTH PRESTON.

Wanted to Buy.

WANTED TO BUY. LAND WANTED. 896 HIGH STREET, THORNBURY (Near Train Terminus).

Wanted to Buy.

WANTED TO BUY. Underwood & Paterson. Auctioneer, Estate Agents, Sworn Valuator.

Wanted to Buy.

WANTED TO BUY. Underwood & Paterson. Finance from £50 Deposit.

When Winter Comes.

When Winter Comes. Underwood & Paterson. Tailor & Mercer.

When Winter Comes.

When Winter Comes. Underwood & Paterson. Finance from £50 Deposit.

When Winter Comes.

When Winter Comes. Underwood & Paterson. Finance from £50 Deposit.

When Winter Comes.

When Winter Comes. Underwood & Paterson. Finance from £50 Deposit.

When Winter Comes.

When Winter Comes. Underwood & Paterson. Finance from £50 Deposit.

When Winter Comes.

When Winter Comes. Underwood & Paterson. Finance from £50 Deposit.

When Winter Comes.

When Winter Comes. Underwood & Paterson. Finance from £50 Deposit.

When Winter Comes.

When Winter Comes. Underwood & Paterson. Finance from £50 Deposit.

When Winter Comes.

When Winter Comes. Underwood & Paterson. Finance from £50 Deposit.

When Winter Comes.

When Winter Comes. Underwood & Paterson. Finance from £50 Deposit.

When Winter Comes.

When Winter Comes. Underwood & Paterson. Finance from £50 Deposit.





Business Notices

Westgarth Dentistry, 80 HIGH STREET, WESTGARTH. (Late Mr. McKelvie's). FOR MODERN UP-TO-DATE DENTISTRY.

COLD WEATHER MEANS WARM HOUSES. ROBERTSON & O'DONNELL, 463 HIGH STREET, NORTHCOLE.

G. DALGLEISH, Up-to-date Watchmaker and Jeweller. We are Watch Experts.

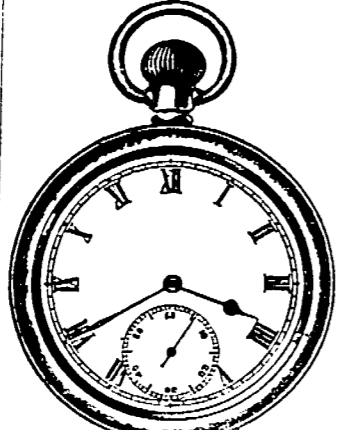

R.I.A. LEVERS. Special 12 Jewel. Lion Control & Nickel. Guaranteed Five Years. 42/

The GRAMAPHONE A Modern Miracle. The Gramophone has become almost a commonplace, yet it is not, by what it achieves, something of a miracle?

New Trading Agency Pty. Ltd. 273 High Street, Northcote. Next door but one to Leeden & Bock's.

MISS WINTER, Milliner and Ladies' Draper. OF TRAM SEEDS. Address: 679 High St., Thornbury.

The HOME of MILLINERY Berlei, the Australian Made, Naturally Fitting Corsets, Wrap-ups and Brassieres.

"ECONOMIST" GAS COOKING STOVES. With Cast Iron Patent Castings and Porcelain Enamel Tray.

FOOTBALL.

NORTHCOTE defeat COBURG.

A SPLENDID CONTEST.

As Saturday last was a magnificent day, a large crowd numbering about 1,000 spectators assembled on the Coburg Recreation Reserve to witness Coburg and Northcote teams try conclusions for the first time this year.

As both Cassidy and Perkins were injured against Williamstown they were omitted from the local side, and Bob Johnson and Anderson were chosen for the vacancies.

Northcote, 3 goals, 15 points. Coburg, 1 goal 6 behinds, 12 points. With commendable dash and suddenness, the home team attacked, and after Beeson had added a behind, Kerley kicked a goal.

Northcote, 3 goals, 15 points. Coburg, 1 goal 6 behinds, 12 points. With commendable dash and suddenness, the home team attacked, and after Beeson had added a behind, Kerley kicked a goal.

Northcote, 3 goals, 15 points. Coburg, 1 goal 6 behinds, 12 points. With commendable dash and suddenness, the home team attacked, and after Beeson had added a behind, Kerley kicked a goal.

Northcote, 3 goals, 15 points. Coburg, 1 goal 6 behinds, 12 points. With commendable dash and suddenness, the home team attacked, and after Beeson had added a behind, Kerley kicked a goal.

PRESTON TRIUMPH OVER VISITORS.

KINGSVILLE'S IMPROVED SIDE.

A Day of Casualties.

With a beautiful spring afternoon, Preston were pitted against Kingsville in the Preston Park last Saturday before a good attendance of spectators.

received a "fluke" mark, but missed a chance. Holiday and Aled Jones, one of the injured players, were seen in carrying on the attack by giving Burt an opportunity of which he was not slow to take advantage.

On the change over, Preston were again attacking, Cahill, whose marking was an outstanding feature of the match, continued the attack.

Northcote Juniors v. Caulfield South. The locals were at home to Caulfield South last Saturday, and there a fair number of spectators present.

Whittlesea and other matches. Whittlesea v. Epping. On Saturday last Epping and Whittlesea met for the first time this season at Whittlesea.

Whittlesea v. Epping. On Saturday last Epping and Whittlesea met for the first time this season at Whittlesea.

Whittlesea v. Epping. On Saturday last Epping and Whittlesea met for the first time this season at Whittlesea.

Whittlesea v. Epping. On Saturday last Epping and Whittlesea met for the first time this season at Whittlesea.

Whittlesea v. Epping. On Saturday last Epping and Whittlesea met for the first time this season at Whittlesea.

Whittlesea v. Epping. On Saturday last Epping and Whittlesea met for the first time this season at Whittlesea.

Whittlesea v. Epping. On Saturday last Epping and Whittlesea met for the first time this season at Whittlesea.

Announcements.

Smith's. SMITH ST. (at Johnston St. Section). NEW STOCK of Guaranteed for Hard Wear. In Stripes of Attractive Design.

BEASLEY'S Rapid Boot Repairs. Edwardes Street, RESERVOIR. A request of many patrons, I have opened Receiving Depots, where work may be left.

JENKINS & CO., 465 HIGH STREET, NORTHCOLE. Blue Star Garage. Proprietors: C. E. JENKINS, E. MCN. ROBERTSON.

Special Bedding FOR THIS WEEK 32s 6d Plain or Fancy Ticking. 4ft. 6in. Well-filled Mattress, Bolster, and Two Pillows (Complete Set).

D. K. ROSS'S FURNITURE STORES, 199, 201, 203, 205 St. George's Rd., North Fitzroy.

A STANDARD OF PURITY. The Bread we sell is made under conditions ensuring its perfect purity and a standard of excellence which no other bread offered to the public has attained.

The Croxton Paint, Oil & Paper Store. 612 HIGH ST., CROXTON. (Close to Martin Street and Tram Sheds). Phone, N'cote 649.



**NORTHCOTE LIBRARY**  
All Privileges Absolutely Free to Ratepayer- and Residents.  
**10,000 VOLUMES.**  
Splendid Juvenile Section.  
Latest Technical, Wireless, Scientific, Motor Car Works, Sporting Books of all kinds by Experts.  
Best Fiction. Finest Literature.  
R. J. WHALLEY, Hon. Sec.

# Northcote Leader

Circulating in Northcote, Preston, Thomastown, Epping, Diamond Creek, Arthur's Creek, Whittlesea, Fairfield, Heidelberg, Clifton Hill

**S. TURNER**  
(Late A.I.F.)  
LANDSCAPE GARDENER, &c.,  
EDWARDS ST., RESERVOIR.  
Gardens Laid Out and Kept in Order.  
Plants of all kinds supplied.  
Paths and Drives in Granolithic, Gravel or Asphalt.  
Manure, Garden Soil, Ashes, &c.  
Any Suburb.

**Dentistry**  
**Dental Advice Free.**  
Mr. C. J. A. TAYLOR, formerly assistant to Dr. Hay North and Dr. W. L. Allen, is now settled in Northcote, Melbourne, at 288 High Street, Northcote. He is a Licentiate of the Royal College of Dental Surgeons, London, and a Licentiate of the Dental Board, Victoria.  
Avail Yourself of My Experience.  
**C. J. A. TAYLOR**  
(Recorded by Dental Board, Vic.)  
288 HIGH STREET, NORTHCOTE  
(near Picture Theatre).  
Phone, Northcote 640.

Price 2d

Registered at the General Post Office, Melbourne for transmission by post as a Newspaper.

Saturday, June 27, 1925

Printed and published by James Horne Hall, for the Proprietors, D. H. Mott & Sons, at their Printing Office, 369 High Street, Northcote, in the State of Victoria.

**Fuel Merchants**  
**RETURN TO LOWER PRICES**  
Gray Box, 1ft. 2/10 18/3 2/17 2/13 1/2  
Red Box, 1ft. 2/8 18/1 2/16 2/10  
Mixed Blocks.  
1 foot 2/8 18/1 2/16 2/10  
Maitland Coal 3/9 13/3 2/11 1/11 2/3  
Maitland Roots 2/9 13/3 2/11 1/11 2/3  
Buy your supplies during the summer months and save money.  
Prime Mill Cut Chaff, Crushed Oats, Bran, Pollard, Straw, Grain, and Poultry Feed of all descriptions always on hand in large and small quantities.  
Deliveries daily. Prices on application.

**Charles Rose**  
66 ST. GEORGE'S ROAD, NORTHCOTE.  
Wholesale and Retail.  
Phone, Northcote 469.  
All orders left with W. McLeod, 83 Hotham Street, Preston, will receive Prompt Attention.

**E. F. Blampied,**  
FUEL MERCHANT,  
83 GLADSTONE AVENUE, NORTHCOTE.

ON SALE:  
Wood, Coal, Coke, and Mallee Roots at Melbourne Prices.

A Trial Solicited. Orders delivered to any address.

Phone, Northcote, 146.

**John Kidd**  
Intimates that his well-known **PRODUCE AND FUEL BUSINESS,** HIGH STREET, CROXTON, will hereafter be run as **J. KIDD & SONS** (Mr. Jack Kidd, late A.I.F.)

The New Firm respectfully solicit a fair share of public patronage. All orders promptly attended to.

**A. C. (Bert) HOOPER**  
DESIRES to inform the Residents of Northcote and Preston that he has purchased the **FUEL AND FODDER BUSINESS** of Messrs Carling Bros., at the corner of St. David and Kaleigh Streets, Thornbury.

He trusts by civility and strict attention to business to merit a share of their patronage.  
Phone N'cote 221.  
Private Address: 38 St. David Street. Orders may also be left with Carling & Sons, 429 High Street, Northcote.

Ring Northcote 252.  
**S. T. Muller,**  
WOOD, COAL AND COKE MERCHANT,  
4 SMITH ST., THORBURY  
(One door from High Street, just behind H. C. Dyer, Chemist).

Best Box Blocks, Black and Brown Coal at Railway Prices.  
All orders promptly attended to. A Trial Solicited.

**Hay, Corn, Wood, and Coal.**

**PETER O'NEILL**  
has for sale  
Chaff, Oats, Bran, Pollard, Fodder, Etc. Wood, Coal, Briquettes, Etc.

443 HIGH STREET, NORTHCOTE (Opposite Brick Co.)

**L. A. Akers,**  
Wood, Coal and Coke Merchants,  
29 DENNIS ST. & 13 DALLEY ST., NORTHCOTE.

Best Box Wood, Split Wood, Iron Bark, and Mallee Roots delivered at Melbourne Prices.  
BRIQUETTES.  
Orders delivered to any address. A Trial solicited.

**Notices.**

**ACCOMMODATION FOR WEEK-TARIFF MODERATE.**

**The Whittlesea Tea Rooms**  
(Opposite Royal Mail Hotel, Walnut St.)  
MRS. H. RICHARDSON, Proprietress

Lunches Provided at all Times - Hot Pies, Fruit and Choice Confectionery. Tobacco and Cigarettes.  
Dining Room Open - Three Course Dinner.  
Cooked Meats a Speciality.  
Hot Water Provided.  
Cool Drinks and Ice Cream.

**M. CHAPMAN**  
(Late Plumbing Inspector M.M.B.W.)  
SANITARY AND GENERAL PLUMBING.

Estimates given for House Connections, Plumbing and Drainage Work. General Repairs. Meters Fixed. Satisfaction Guaranteed.  
29 KEMP STREET, CROXTON.

Phone, Northcote 1468.  
**E. Weightman,**  
MOTOR CARRIER.

CARRIES WHAT? ANYTHING—EVERYTHING.  
Solicits Local Work.  
Boat, Rail, City and Suburbs. Pleases Attended.

**PRELAN STREET, PRESTON.**

Established 38 years. Phone, Northcote 1201.  
**Arthur R. Bostock,**  
Hay, Chaff, Straw, Grain and Seed Merchant,  
481 High Street, Northcote.  
Wood, Brown and Black Coal, Mallee Roots, Briquettes.  
POTATOES. ONIONS. Clothes Lines and Props. Chicken and Canary Grit. Shell Grit. Oyster Grit. Quartz Grit. Agents for Clarke, King, White & Handcock, Tzack's. Chicken and Poultry Requisites. Feeds, Condiments, Spices and Medicines. Karswood Spices. Dog Biscuits.  
Oat Hulls, Hulled Oats, Oats, Part. Peas, Bran, Dun Peas. Canary, Finch, Parrot and Cockatoo Seeds.  
Malt Combing, Pollard, Mixed Grain. All kinds Vegetable Seeds. Poly Feed, Wheat, Growing Grain, Molasses, Wheat Screening, Growing Mashies for Chickens, Lucerne Chaff, Maize, Laying Mashies, Maize Meal, Pen Meal, Lupul, Barley, Barley Meal.  
Market Garden Manures. Blood and Bone Manure, Bone and Super Manure, Bone, Blood, Sulphate of Ammonia, Red Oil for Spraying.  
Meat Meal, Broom Meal, Bone Meal, Boneoline Emulsion, Singer's Egg Producer, Mervel, Pestoid, Vermin Powders, Drenches, Condition Spices, Colic and Cough Cures for Horses and Cattle, Oil Cake, Calf Food, Sulphur, Salt Petre, Blue Stone, Resin, Gail Cures, Solonson's Solution, Rock Salt and Salt Licks, Lime, Cement, Axle Oils, Greases, Leather Oils and Harness Dressings, Stockholm Tar, Halters, Brooms, Axe and Broom Handles, Whips, Poultry and Pigeon Rings and Leg Bands, all sizes, Egg Preservatives, Twine, and Tar.



**Plenty Motors Pty. Ltd.**  
214 High Street, Preston,  
announce

**BIG REDUCTIONS**  
in the prices of  
**FORD CARS AND TRUCKS.**

Note them. DE LUXE TOURER ... £199/10- Very Easy Terms. STANDARD TOURER ... £179/10- ONE-TON CHASSIS ... £148

**MAC'S Steam Laundry,**  
656 High Street, Thornbury.  
(O. Du Feu, Prop.)  
ESTABLISHED LAUNDERERS—NOT AGENTS.  
Collars Ironed and Polished Perfectly and Shipped to fit you in comfort. NOT BROKEN BY OUR NEW METHOD.  
Dress Shirts done by us are a feature.  
Motor Coats, Curtains, Blankets, Table Cloths, Costumes, Quilts, Sheets, And EVERYTHING WASHABLE.  
Don't have the unpleasant wash day at home. We call and deliver any address for your household linen. Wash and iron it ready for use again. You save the washerwoman and firewood expense.  
Just Try it and see how Happy Home Life will be. Apply to us for Price List.

"The Best Flour"  
Says a Leading Food Analyst  
"That I have tested during my 17 years' experience, I proved the absence of lead, sulphate, and baking powder substitutes. I attribute the quality to the purity of ingredients used."  
Buy the Best. Leave the Best. Maltin's is superior and packed in germproof cartons.  
**MALTO-PEPSIN SELF RAISING FLOUR**

**Hooper's Northcote Auction Mart,**  
Established 1920  
Note Address: 336 High Street (Opp. Henderson's, Butcher).  
General Auctioneer.  
Sales in Rooms fortnightly—FRIDAYS at 1.30. Furniture, Poultry, &c., Sold on Commission. Goods also sold Privately for Vendors. We send our Wagon anywhere Promptly. Large Rooms for Display of Goods.  
A Large List of House Properties.  
Auction Sales of Furniture and Properties Conducted on Premises.  
PHONE, N'COTE 948

**W. SMITH,**  
GENERAL MOTOR CARRIER,  
Murray Road East, Preston  
Furniture Carefully Removed to Any Suburb.  
Boat and Kall Attended. Picnic Parties Catered for.  
Phone, Northcote 923

**R. B. LAWRENCE**  
PTY. LTD.  
Dyers, Cleaners, and Feather Dressers,  
Suits or Dress like New by Latest Process.  
Goods may be left at Office and Works: Cunningham Street, Northcote. Shops: Flin's Building, 6A Elizabeth Street (next Craig's), Royal Arcade, Bourke Street, and all Suburbs. Phone 24630, and Van will call.  
NOTE.—WE HAVE NO SHOPS IN NORTHCOTE.

**TANKS**  
Mr. Country Resident:  
Have you considered the tank question carefully enough? If you run short of water it means much inconvenience—perhaps even hardship.  
So just think now: Is your supply big enough to hold against drought? If not, take steps immediately to get into touch with us.  
We make tanks any size, any shape and at very moderate charges.  
**W. J. INGLIS PTY. LTD.**  
The Preston Timber Yard and Hardware Stores, Glazing and Joinery Works  
Cr. Plenty Road and Osborne Grove, PRESTON  
Phones—N'cote 1209 and 737

**GRAVEL! GRAVEL! GRAVEL!**  
Just What's Wanted for  
Garden Paths, Yards, and Public Highways.  
Supplied in any Quantity and at FIRST COST, direct from the Ruckers Hill Gravel Pit.  
Order Now, before the Wet Season arrives.  
Full Information at—  
44 James Street, Northcote.  
Letters Promptly Attended to. Phone, Northcote 776

Phone, Northcote 1166.  
**Nankervis & Spurr**  
(Late Kellow-Falkiner),  
Motor Engineers,  
209-211 High Street, Northcote  
(Opposite Northcote Theatre)

All Makes of Cars Overhauled and Repaired. Tuning and Electrical Systems a Speciality. First-Class Work at a FAIR-DEAL PRICE. Full Supply of Petrol and Oil always on hand.  
**Let Us Quote You for your Next Engine Overhaul.**

**DAREBIN MOTORS**  
"THE FIRM WHO CARES."  
Authorized Agents for—  
**CHEVROLET**  
Cars and Trucks.  
Demonstrations with pleasure. We have Expert Mechanics and we Specialise in Ford Repairs. A Complete Stock of Genuine Ford Parts and Accessories. So Bring Your Ford Car to us for inspection. **TRY OUR MOTOR SPIRIT** 100 gals. Sold Daily. Phone N'cote 1215.  
SHOW ROOMS AND SERVICE STATION—  
96 HIGH STREET, PRESTON.

Be Up-to-Date and have Electric Light Installed in Your Home.  
Clean. No Matches. No Mantle Bills. A Pleasure to Read or Work by. Installations Cheaply and Promptly Executed by

**H. P. LEE, Electrical Contractor**  
228-230 High Street, Preston.  
Every Class of Electrical Work Undertaken and Satisfaction Guaranteed.  
Phone, Northcote 108.

**T. H. NEAVAN, Farrier,**  
Desires to notify the Public of Northcote, Preston, and surrounding districts that he has taken over the Business lately carried on by Mr. J. S. BURNS, at  
417 HIGH ST., NORTHCOTE  
(Next Corner Elm Street).  
Full Experience. All Work Guaranteed.

**FURNITURE**  
REMOVED PACKED OR STORED  
CHEAPLY and WITH CARE BY  
**Knapp & Mitchell,**  
82 Helen Street, Northcote.  
Phone, Northcote 253  
Sand, Garden Soil, Ashes, and General Carting Done.

Phone, Northcote 222  
**T. A. Sands,**  
Leather and Grindery Depot,  
333 High Street, Northcote  
Boot Repairs a Speciality.  
The Shop where you will get Full Value for Your Money.  
A Few of My Prices:  
Solid Leather School Bags, 2/- each.  
Child's Lunch Cases, 1/- each.  
Men's Solid Leather Lunch Bags, with strong lock, only 8/-  
Lovely 20in. Suit Case of Strong Fibre, 8 Vulcanite Corners and 2 Strong Locks, 12/6 each.  
Ladies—See Our Lovely Shopping Cases from 7/6 each  
We carry a Large Selection of Globite and Solid Leather Attache and Suit Cases, also Ladies' and Gents' Wallets.  
Men's Leather Half Shoes, 1/- per pair  
Men's Rubber Heels, 3d pair; 5 pairs, 1/-  
Strong Boot Laces, 2d per doz.

**L. H. TADICH'S**  
**MOTOR GARAGE**  
802 High Street, Northcote  
(TRAM TERMINUS).  
Authorized Sole Agent for  
**Oldsmobile Six, £340** Standard Tourer De Luxe, £845  
Fitted with Balloon Tyres. CASH or TERMS.

Your Old Car Taken in Part Payment.  
Demonstrations with Pleasure at Your Leisure.  
REPAIRS BY EXPERTS. COMPLETE SERVICE.  
Try our First Grade Motor Spirit.

**Normanby Hall,**  
Normanby Avenue, Thornbury  
Available for Weddings, Parties, and Dances.  
**Bell's High-Class Catering**  
either at or away from the Hall.  
Highest Satisfaction Guaranteed. Goods on Hire.

**The Northcote Red Granolithic Footpath Experts**  
**A. A. FAIRWEATHER & SONS**  
(Returned Soldier).  
35-37 Herbert St., Northcote  
Footpaths, Garage Drives, Factory and Shop Floors Laid Down and Finished to Satisfaction.  
Cement Steps and Drains to match path.  
All Work Done by US Guaranteed. Material & Workmanship Perfect.  
For Particulars, Ring Northcote 1747.

**Sulphate of Ammonia**  
The Ideal Nitrogenous Fertilizer  
For Lawns, Flower and Vegetable Gardens.  
100 per pkt., containing approx. 5 lbs.  
For Renovating Paths, Asphalt Yards, &c.  
45 per tin, containing approx. 4 gallons.  
Obtainable at ALL DISTRICT DEPOTS.  
Further Particulars from the Producers.  
**The Metropolitan Gas Company,**  
196 FLINDERS ST., MELBOURNE.

**Meet Health Every Day!**  
The Purest and Most Nourishing of all Drinks for the Invalid as well as for the Healthy—  
**F. Lanteri's Pure Australian Wines**  
Have been awarded Prizes at the Royal Agricultural Show for the past 7 years, proving their fine quality.  
OUR ROYAL GRAND SUPREME PORT is highly recommended for Invalids, and is guaranteed equal if not superior to the best imported.  
Wines of the best Vintages always in stock.  
We supply an Assorted Dozen of High-Class Wines, in repute quarts, at from 24/- doz. delivered anywhere.

**F. LANTERI, Wine Merchant**  
812-814 High Street, Upper Northcote.

**Commercial and General PRINTING ORDERS**  
Executed to Your Satisfaction at the  
**"Leader" Office, Northcote**  
Phone, Northcote 46

**C. J. GORDON GILLIES**  
L.D.S., R.D.S.C.,  
Melbourne University,  
SURGEON DENTIST,  
HIGH STREET, THORBURY  
(next Davis, Chemist).

Hours: 9.30 a.m. to 1 p.m., 2 p.m. to 6 p.m.  
Monday and Friday, 7 p.m. to 9 p.m.

**MR. GEORGE M. ALLEN,**  
SURGEON DENTIST,  
14 GERTRUDE ST., FITZROY.  
Announces that he has established a Branch of his practice at 140 High St., Preston South, and he may be consulted there every evening and on Saturdays. Week-day appointments must be made previously to ensure of prompt attention.  
Telephone, J1613.

**MR. J. E. ANDREA,**  
L.D.S., R.D.S.C.,  
MELBOURNE UNIVERSITY,  
SURGEON DENTIST,  
763A HIGH STREET, THORBURY  
(3 doors from Dyer, Chemist).

Hours: 9 a.m. to 6 p.m. Daily.  
Monday, Wednesday, and Friday, 7 to 9 p.m.

Phone, Northcote 1932

**Electrical Installations**  
Guaranteed All British.  
No Wool Casings. No Japanese  
24/- per Light.

**F. QUAIFE,**  
LICENSED CONTRACTOR  
"Airlie," Collins St., PRESTON.

**Johnston & McMillan,**  
ELECTRICAL CONTRACTORS,  
666 HIGH STREET NORTHCOTE

Private Addresses:  
25 Fenwick Street, Northcote.  
And cnr. Wales & Rosemaryne Sts.

Electric Lights, Fans, Motors, and Anything Electric Installed.

REPAIRS A SPECIALITY.

ALL WORK GUARANTEED.

Estimates Free. Phone—N'cote. 471.

**Bell Fibro-Plaster Sheets**  
(All Sheets Branded).  
MADE ALL SIZES.

Inspect at Factory before Ordering Elsewhere.

BLANCH STREET, PRESTON (near Bell Station).  
Phone, Northcote 1482.

**LONDON**  
Fire Assurance.

You can insure your Buildings, Furniture, Stocks-in-Trade against Fire at Lowest rates.

Consult Local Agent,  
**ERNEST LEES**  
307 HIGH STREET, NORTHCOTE.  
Telephone, Northcote 54.

**"Rona" Dairy Farm**  
Farm and Dairy:  
SPRING STREET, PRESTON.  
Pure, Fresh Milk, direct from our own cows, delivered twice daily in Preston and surrounding districts.  
Premises and Cattle under Government supervision.  
Our Milk is guaranteed free from preservatives and coloring.  
Post Cards promptly attended to.  
The favor of your patronage and recommendation respectfully solicited.

**B. EDMONDS,**  
LICENSED DAIRYMAN.

**Undertakers**  
Telephone J1050.  
**H. J. R. LEWIS,**  
UNDERTAKER  
And CHRISTIANIZED EMBALMER,  
HIGH ST., NORTHCOTE.  
Head Office:  
Corner Johnston & Hordford Sts. Fitzroy.

Funerals conducted at the lowest possible rates.  
Hearse, Mourning Coaches, and Funeral Requisites.  
The Trade supplied.

Established 1856.  
**W. G. APPS Pty. Ltd.**  
UNDERTAKERS,  
MOOR STREET, FITZROY.  
High and Burgundy Streets, St. Kilda.  
Branch: Burgundy Street, Heidelberg.  
Phone, Heidelberg 04.

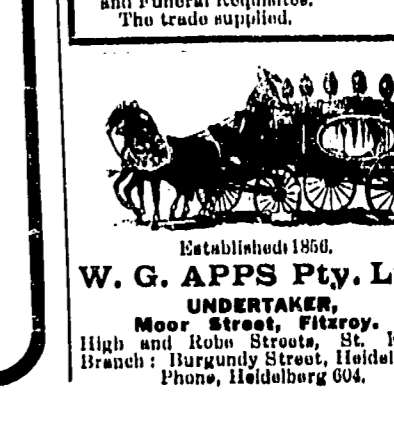







Notices
J. W. MOUNSEY, Fuel and Fodder Merchant. 370-386 High Street, NORTHCOTE. All Classes of Fuel Kept in Stock. Phone, Northcote 1454.

SEE THE DISPLAY IN AUTUMN HATS at the RENE MILLINERY PARLORS, High St., Northcote (cnr. Beaver's Road). Mrs. D. GREEN, Proprietress.

The Right Place to Buy the Right Gifts. JEWELLERY is the Gift of Gifts, and whether it be a Diamond Ring or some simple little article for a Lady's Toilet Table it should be of good quality. Wm. Thackray 313 HIGH STREET Northcote.

PAINT PRIDGEON'S DURALINE PAINT. White and Colors at 17/6 gallon. 391 High Street, Northcote. Pridgeon's Paint and Paper Store.

CAHILL & SONS 242 St. George's Road, Croxton. Licensed Sanitary Plumbers. ESTIMATES SUBMITTED. HOT WATER A SPECIALTY.

XMAS 1925 Your Calendars Order them from "LEADER" OFFICE, 309 High Street, Northcote. D. H. MOTT & SONS, Proprietors.

WIRELESS By R. J. COLLINS. The more the operator knows about the theory of his receiver the better he will be able to work it. This note also stands for any other machine, but in radio there is a far greater fascination to know just why one can hear people speaking in Sydney at one moment, and by merely twisting a dial round a few degrees hear an orchestral selection being played in Adelaide or a jazz band in Perth.

RADION ELECTRIC COY. Radiators a Speciality Radio Parts of Every Quality WE CATER FOR ALL. ELECTRIC IRONS, RADIATORS, Headphones, 17/6. All Classes of Electrical Engineering.

Lighting Installations Done. Up-to-date Battery Charger. La Vinnette Toilet Parlors 113 High Street, Northcote South. Latest Hair Cuts, Treatments, Dyeing, Singeing, Manicuring, Etc.

SMITH & CULLEN. SIGNWRITERS. 77 PRINCE STREET, NORTHCOTE. GLASS GILDING, CALICO AND POSTER SIGNS, MOTORS, ETC. Phone, Northcote 1656.

NORTHCOE POLICE COURT. MONDAY 22ND JUNE. (Before Messrs W. Hayes, A. H. O'Neil and J. Cohen, J.P.s.)

OVERLOADED BUSES. Nathan Schwartz, Lee street, North Carlton, was charged on 16th May being the driver of a licensed motor bus within the eight miles of the City of Melbourne he did carry more passengers than the limit allowed.

HINTS ON TUNING. A receiving circuit is stated to be in tune when the wave length to which it responds best is exactly the same as that of the transmitting station.

MAINTENANCE. Ethel Walkadine sued Theodore Walkadine, Gladstone avenue, Northcote, for maintenance for herself and child.

THE BENCH. Mrs. Shingler, mother of previous witness, said six weeks ago she came to Melbourne and was treated by a doctor at the way Walkadine treated his wife.

THE BENCH. Mrs. Shingler, mother of previous witness, said six weeks ago she came to Melbourne and was treated by a doctor at the way Walkadine treated his wife.

WHITTESSA NEWS. Mr. John Perkin, of Eastern Hill, Whittlesea, an old and respected resident died on Monday after a short illness.

RECEIVED. Several new types of aircraft have been designed especially for marine use in conjunction with the Navy.

PENDER'S GROVE SCHOOL. CORONATION CEREMONY. On Tuesday, 16th June, the bazaar run by the Mother's Club of the Pender's grove school was brought to a successful conclusion by an entertainment given in the Pender's grove hall.

THE WINNER. Miss Kathleen Hogben (10th grade), Queen of Summer, delightfully garbed in ivory crepe de chene, applied with sprays of summer flowers, and wearing her emblems and robes of office, seated upon a raised dais, and surrounded by her court, formed the centre of a particularly beautiful and striking tableau.

THE TOTAL AMOUNT. The total amount realised in connection with this effort of the Mother's Club was £210. Of that sum £60 was the queen's prize; the 5th and 4th grades being responsible for the raising of £120 and £30 respectively.

PRESTON COUNCIL SUPPORTS. The Preston council on Monday night received a letter from the shire clerk, shire of Whittlesea, requesting the co-operation of council in an endeavour to have the railway from Reservoir to Whittlesea electrified.

THE BENCH. Mrs. Shingler, mother of previous witness, said six weeks ago she came to Melbourne and was treated by a doctor at the way Walkadine treated his wife.

THE BENCH. Mrs. Shingler, mother of previous witness, said six weeks ago she came to Melbourne and was treated by a doctor at the way Walkadine treated his wife.

RECEIVED. Several new types of aircraft have been designed especially for marine use in conjunction with the Navy.

RECEIVED. Several new types of aircraft have been designed especially for marine use in conjunction with the Navy.

Soccer. Preston journeyed to Crith Point to play the Navy in the League Tournament, and took a fair number of supporters with them.

PRESTON RESERVES. Preston A team met Brighton A team in the Reserve League, at Bell Park, although weathered by the first team calling upon them to fill the vacancies.

PRESTON SWIFTS. The Swifts met Brunswick B, at Bell Park on Saturday, in the Junior League. This team is the best in this competition.

PRESTON ALBIONS. The Albions made a journey to Newport last Saturday to play Newport in the League. These boys are very enthusiastic about soccer, and are playing like old singers, and although they lost, could not be blamed.

RESERVOIR ROVERS. The Reservoir Rovers journeyed to Box Hill last Saturday to play their first match in the fourth division of the League, and played a fair game.

STAR OF NORTHCOE TENT, I.O.R. The fortnightly meeting of the above was held in the Rechabite hall on the 14th inst., the chief ruler (Bro. G. McWilliams) presiding over a fair attendance of members.

RECEIVED. Several new types of aircraft have been designed especially for marine use in conjunction with the Navy.

RECEIVED. Several new types of aircraft have been designed especially for marine use in conjunction with the Navy.

Law. MADDOCK, JAMIESON, AND LONIE, SOLICITORS AND CONVEYANCERS, 188 and 189 Queen Street (between Bourke and Little Collins Streets), Melbourne.

MADDER, DRAKE & CANDY SOLICITORS & CONVEYANCERS, "THE OLDFLEET" (First Floor), No. 476 COLLINS STREET. Telephone, Central 198.

HOME AND WILKINSON. SOLICITORS, CONVEYANCERS, &c. Commercial Union Chambers, 418 Collins Street, Melbourne. And at No. 323 HIGH ST., PRESTON.

W. R. V. A. L. E. BARRISTER & SOLICITOR, CONVEYANCER & PROCTOR, 148 CHANCERY LANE, MELB. And 45 HOODLE STREET, ABBOTSFORD. Telephone, Central 3302.

M. R. S. R. O. E. SOLICITOR, &c. 192 HIGH STREET, NORTHCOE (opposite Post Office) Is now consulting at the above address where he resides and may be consulted at any time.

R. R. G. R. A. Y., L.L.B. BARRISTER AND SOLICITOR, CONVEYANCER AND PROCTOR. Every kind of Legal Work attended to. Address: 57 James St., Northcote. TEL. N. COTE 166.

NICHOLAS O'DONOHUE, BARRISTER AND SOLICITOR, may be consulted any evening at his Residence, 783 HIGH STREET, THORNBURY. City Office: 422 Little Collins Street. Phone: 32022 Central 11197. Trust Money to Lend. Neighboring Courts Visited.

NORRIS & NORRIS, BARRISTERS AND SOLICITORS. A. J. NORRIS, L.L.B. Commissioner for taking Affidavits. CITY OFFICE - Bank of New Zealand Chambers, 348 Collins Street. NORTHCOE OFFICE - 682 High Street. PRESTON OFFICE - Star Theatre Buildings, High Street. Phone: Central 2542. Private: Northcote 1493, Ivanhoe 269.

Announcements. IF YOU WANT YOUR JOB TO LOOK WORTH WHILE, Write to William H. Day, PAINTER, PAPERHANGER, AND GRAINER. Estimates for General Repairs. Temporary Address: P.O. RESERVOIR.

STOP! Car for Hire. LUXURIOUS 7-PASSENGER BARLEY SIX. DAY OR NIGHT. WEEK-END TRIPS A SPECIALTY. CARS REPAIRED in our own Machine Shop. No Repair Too Big. No Job Too Small. Phone, Northcote 1940. F. M. ALONE, 11 BROOKE STREET, NORTHCOE.

Business Announcements. SWITCH ON Radiators and Keep the Cold Out. Look at This: The Northcote, 45/- The Thornbury, 49/6. These Radiators are Locally Made and are made to give Satisfaction and Service. Large Stocks of other Lines from 32/6. E. W. BRIGHTON, Electrical Engineer and Contractor. Tram Terminals, 820, High Street, Thornbury. LIGHTS. MOTORS. ANYTHING ELECTRICAL INSTALLED.

MONEY FOR PRIVATE LOANS. Any Married Lady or Person in Constant Work can obtain a Loan £3, £5, £10 Upwards. At a Private House, Without Security, Lowest Interest and Small Weekly or Fortnightly Repayments. Absolute Privacy Guaranteed. Call, Write or Phone N. Cote 854. JAMES SMITH, 42 GORDON GROVE, NORTHCOE (Near Merri Station). Hours: 9 a.m. to 9 p.m. Saturdays, 9 a.m. to 1 p.m.

Business Notices

Westgarth Dentistry, 80 HIGH STREET, WESTGARTH. FOR MODERN UP-TO-DATE DENTISTRY.

COLD WEATHER MEANS WARM HOUSES. ROBERTSON & O'DONNELL, 463 HIGH STREET, NORTHCOTE. Electrical Engineers.

G. DALGLEISH, Up-to-date Watchmaker and Jeweller. We are Watch Experts.

R.J.A. LEVERS. Special 15-Jewel High-Grade 42/-. Our SPECIAL HIGH-GRADE 25/-.

The GRAMAPHONE A Modern Miracle. The Gramophone has become almost a commonplace, yet it is not by what it achieves, something of a miracle?

New Trading Agency Pty. Ltd. Have transferred their Parlours on a Very Much Enlarged Scale from 761 High Street, Thornbury, to

MISS WINTER, Milliner and Ladies' Draper. OF TRAM SHEDS. Address: 679 High St., Thornbury.

The HOME of MILLINERY Berlei, the Australian Made, Naturally Fitting Corsets, Wrap-ons and Brassieres, also D. & A., W. B., Nautilus, Lady Ruth, Youth Line Redusa, etc., etc.

"ECONOMIST" GAS COOKING STOVES. With Cast Iron Patent Casings and Porcelain Enamel Tray. Separate Oven and Roaster. Will Toast, Roast, Bake, Grill, &c.

FOOTBALL.

NORTHCOTE defeats BRIGHTON. A FOUR POINTS VICTORY.

Exciting Last Quarter.

IS NORTHCOTE TO WIN THE PENNANT? Northcote, by winning last Saturday, now stands with Brunswick at the head of the list, both teams having lost one match.

Those who visited the Northcote Park last Saturday, to witness the second meeting for the pennant, Northcote and Brighton, were well rewarded with a match that staged the most thrilling finish seen in the local ground for many years.

Each side made changes in their ranks. The visitors included Dore, Stephenson, a former Northcote player, and Dandy, in place of Griffith, Lynch and Eric Northcote.

At quarter time, the scores were: BRIGHTON: 1-6, 12 pts. NORTHCOTE: 1-2, 3 pts. Immediately on resumption, Northcote inspired their supporters with a forward rush, but the first result of the attack when Kelle repulsed

At half time, the locals were one point behind, the scores being: BRIGHTON: 3-10, 28 pts. NORTHCOTE: 4-3, 27 pts. After the interval, Baggott played centre-forward. Cassidy forward wing, and Theobald half-forward.

At quarter time, the scores were: BRIGHTON: 1-6, 12 pts. NORTHCOTE: 1-2, 3 pts. Immediately on resumption, Northcote inspired their supporters with a forward rush, but the first result of the attack when Kelle repulsed

At half time, the locals were one point behind, the scores being: BRIGHTON: 3-10, 28 pts. NORTHCOTE: 4-3, 27 pts. After the interval, Baggott played centre-forward. Cassidy forward wing, and Theobald half-forward.

At quarter time, the scores were: BRIGHTON: 1-6, 12 pts. NORTHCOTE: 1-2, 3 pts. Immediately on resumption, Northcote inspired their supporters with a forward rush, but the first result of the attack when Kelle repulsed

Announcements.

Resident of Thomastown, Epping, Woollert, Woodstock, and Surrounding Districts.

BEASLEY'S Rapid Boot Repairs.

At the request of many patrons, I have opened Receiving Depots, where work may be left. Any work left in the morning at times stated may be had same evening if required.

JENKINS & CO., 465 HIGH STREET, NORTHCOTE.

Blue Star Garage

Proprietors: (late Talbot Factory, England). E. MCN. ROBERTSON, Electrical Expert.

D. K. ROSS & CO., COMPLETE HOUSE FURNISHERS,

197, 199, 201, 203, 205 St. George's Rd., North Fitzroy

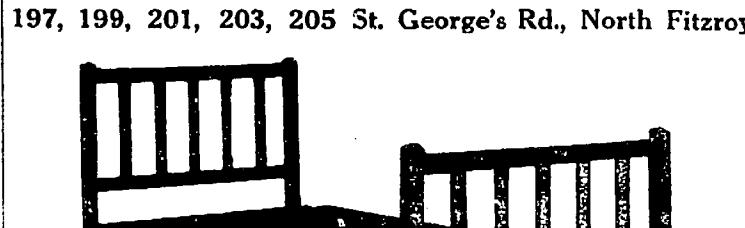

NORTHCOTE JUNIORS V. BRIGHTON DISTRICT.

The local juniors, and a large number of their supporters went to Brighton last Saturday and played Brighton District, in the presence of a large number of spectators.

A STANDARD OF PURITY

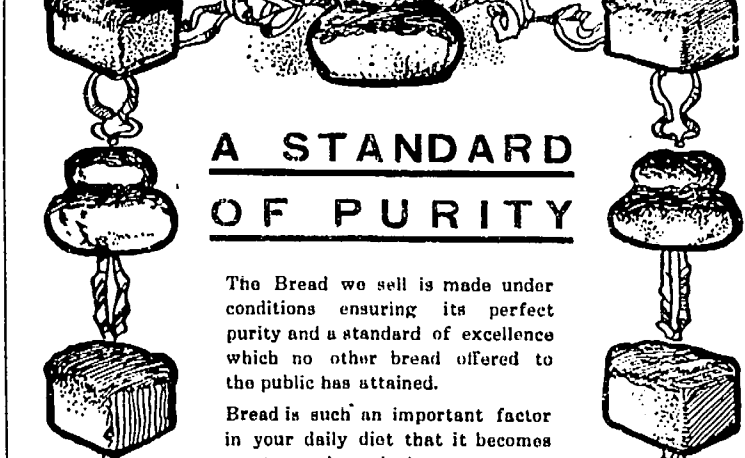

CALLANDER, The Better Baker

PRESTON AND HEIDELBERG. Phone: Northcote 40, Heidelberg 69.

The Croxton Paint, Oil & Paper Store

612 HIGH ST., CROXTON (Close to Martin Street and Train Sheds). Phone, Northcote 649

McEntee & Poole.

Phone, Whittlesea 14

Whittlesea Motor Garage

Authorised Ford Dealer for the District. Only Genuine Ford Parts stocked, Fitted, and Work Guaranteed.

Standard Tourer, D.8. & S.8., 1 Ton Truck (Chassis), £148 with Self-Starters, £179/10/-

De Luxe Model, £190/10/- (with self-starter) 1 Ton Truck Chassis (fitted 4 gears) £170

Model T. Lorries, £170/10/- Fordson Tractor (with pulley) £180

Boysers Taught to Drive FREE. Also Agent for Autocar Industries Products.

BERT WAILES (Late A.I.F.)